



# Modifikasyon Zonaj

Fèm ti pou Zonaj Rezidansyèl,  
Chanjman Zonaj Plas ak Ri

Reyinyon Piblik

# Bouton Kontwòl Zoom pou Koute Entèprèt yo



**(EN)** Look for the interpretation icon (globe) at the bottom of your screen and select the language you want to hear.

**(Kreyòl Ayisyen)** Chèche ikòn entèpretasyon ki gen fòm (glòb) anba ekran ou an epi seleksyone lang ou vle tande a.

**(Español)** Busque el ícono de la interpretación (globo) en el borde inferior de su pantalla y seleccione el idioma en el que desea escuchar.

# Enfòmasyon sou Reyinyon Zoom nan ak Konsèy

- **BPDA pral anrejistre reyinyon sa a** epi l ap pibliye l sou paj entènèt pwojè BPDA a. Si w pa vle nou anrejistre w pandan reyinyon an, tanpri fèmen mikwo w ak kamera ou.
- **Bouton kontwòl Zoom yo disponib anba nan ekran w lan.** Lè w klike sou senbòl sa yo, w ap aktive diferan fonksyonalite.
- **Itilize fonksyon "leve men" an** (konpoze \*9 epi \*6 si w ap patisipe nan telefòn) **epi tann yo rele w** anvan w poze kesyon oswa anvan w fè kòmantè.



Fèmen mikwo a/louvri  
mikwo a

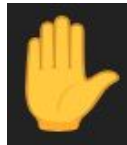

Leve men w pou mande  
pèmisyon pou poze yon  
kesyon oswa pou fè  
kòmantè



Aktive oswa  
dezaktive videyo

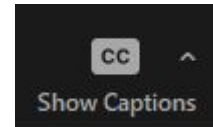

Aktive soutitraj  
la

# Tanpri Mande Eksplikasyon!

**Poze kesyon pandan konvèsasyon an ap fèt** – ekip nou an disponib pou reponn pandan prezantasyon an!

**Mande pou nou eksplike nenpòt tèms oswa konsèp nou te pale sou yo** – nou vle asire nou sa n ap pale a fasil pou tout moun konprann yon fason pou nou tout kapab di sa nou panse selon konpreyansyon nou!



# **PLAN: Rekòmandasyon Mattapan yo**

# PLAN: Mattapan

**PLAN: Mattapan se yon pwojè planifikasyon Vil ki vize bati yon demen ki ekitab epi ki baze sou kominote pou Mattapan.**

## PLAN: Mattapan anvizaje yon avni kote:

- Pou kounye a, rezidan Mattapan yo **estab nan kay yo** epi nouvo rezidan yo **gen opsyon lojman abòdab**
- Moun ki abite Mattapan yo gen **mwayen transpò piblik ki an sekirite epi ki fyab** pou yo ale travay, lekòl, ak nan espas kominotè nan Mattapan ak nan tout Boston
- **Mattapan Square** ak lòt sektè nan katye yo gen **biznis lokal ki dinamik, k ap pwospere ak espas kiltirèl** ki reflekte bezwen rezidan yo epi ki ranfòse idantite katye a



# Sektè Rezidansyèl: Devlopman san Deplasman

Selon PLAN an, li enpòtan pou konsantre sou kreyasyon lojman ki byen chita kò yo nan anviwònman yo epi ki disponib an kantite ki sifizan: Objektif Mattapan se reponn ak bezwen epi priyorite kominote a, pandan li ap asire l Mattapan kapab rete yon espas kote fanmi yo kapab etabli yo epi viv ladan l pandan lontan.

*Men sa rezidan Mattapan yo fè konnen yo bezwen:*

- Lojman pou plizyè jenerasyon
- Plis posibilite pou vin pwopriyete kay
- Lojman pou granmoun ki rantre nan laj
- Plis lajan pou pèmèt yo peye depans chak jou yo
- Lojman ki pa chè ki adapte ak diferan kalite fanmi
- Yon kominote kote fanmi yo kapab viv alèz pandan plizyè ane

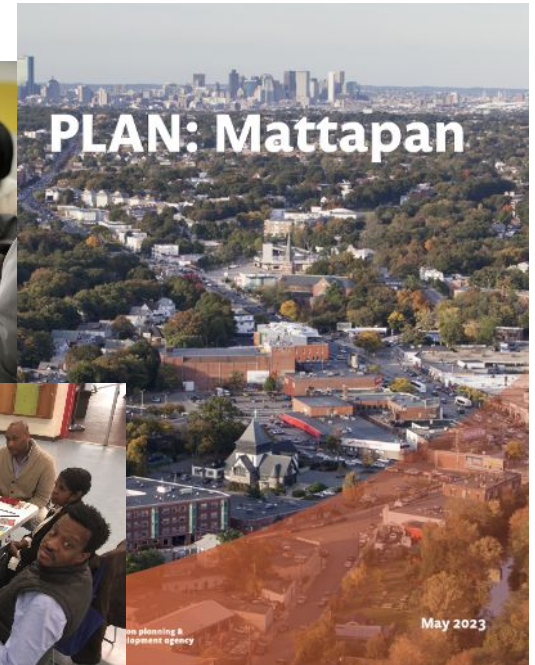

# Divèsifye Opsyon Lojman yo avèk ADU yo

**ADU yo se kèk inite siplemantè yo kapab konstui swa anndan yon kay ki te deja konstui swa pa deyò ka la, tankou yonti kay ki detache pou yon sèl moun rete.**

ADU yo pèmèt pwopriyetè yo itilize pwopriyete yo a nan tout kapasite l epi fè sa ki pi bon an pou reponn ak bezwen fanmi yo.

- Plis espas pou fanmi k ap ogmante epi pou pèmèt plizyè jenerasyon viv toupre youn ak lòt
- Bay opòtinite pou fè plis lajan gras ak yon inite lokasyon ki sou plas
- Ogmante valè yon byen imobilye



*Egzanp ADU ki nan lakou dèyè, youn ladan yo gen yon garaj yo amenaje (sa ki nan mitan an).*



# "Pwen Santral" ak "Aks": Zonaj pou Divès Aktivite

Fè Mattapan tounen yon kominote kote moun yo kapab jwenn byen fasil bagay yo bezwen, sèvis, espas ouvè, ak opsyon transpò piblik se te youn nan prensipal objektif PLAN: Mattapan.

Nouvo zonaj pou divès aktivite nan Plas ak Ri nan Mattapan kapab fè vin genyen biznis lokal ak destinasyon kiltirèl ansanm avèk lojman ki fè moun yo vin pi pre travay yo, transpò piblik, ak lòt sèvis yo.

*Men sa rezidan Mattapan yo fè konnen yo bezwen:*

- Destinasyon kiltirèl, aktivite, restoran kote moun chita pou manje, mache, gadri, ak espas pou rasanbleman
- Biznis ki anba lakay nan zòn komèsyal ki enpòtan nan Mattapan

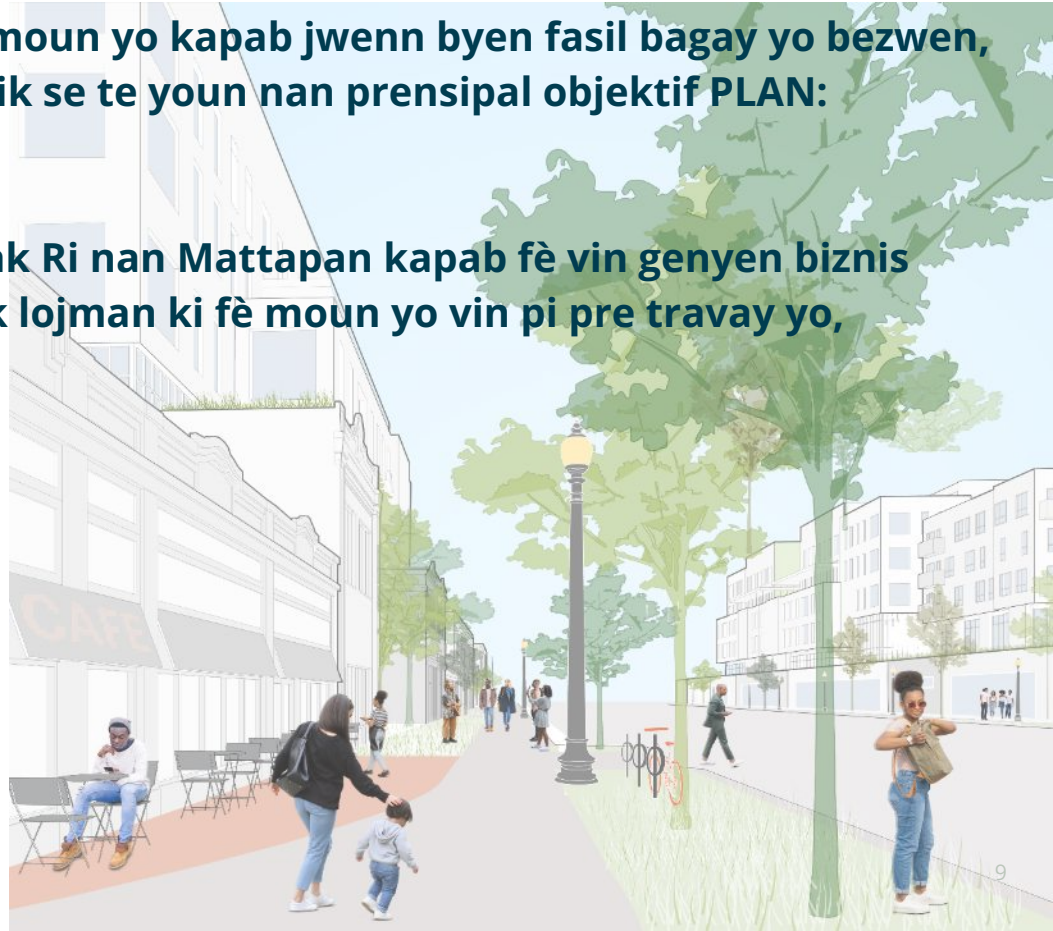

# Pwosesis ak Kalandriye Zonaj Rezidansyèl la

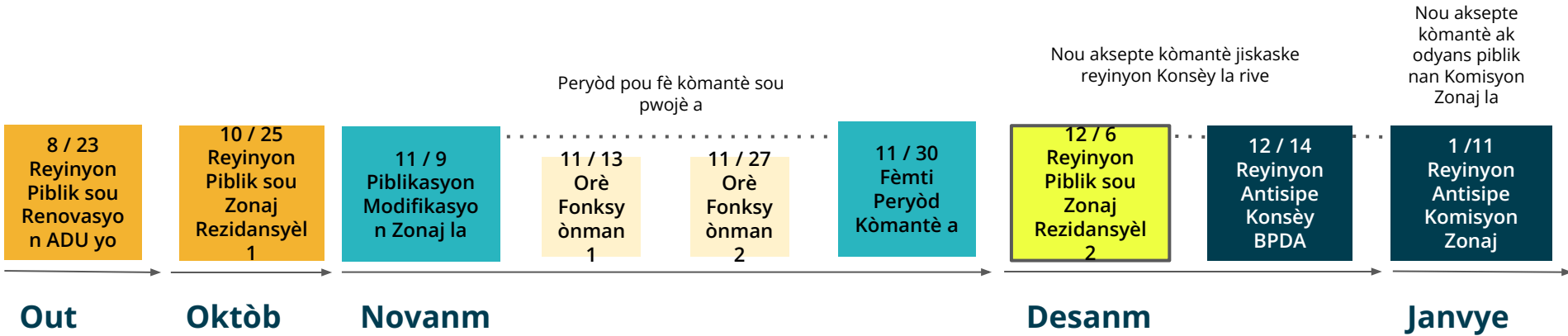

# Pwosesis ak Kalandriye Zonaj Plas ak Ri

## Plas ak Ri Mattapan (Aplikasyon Amandman Tèks la nan Tout Vil la)

Peryòd pou fè Kòmantè sou Pwojè a

Nou aksepte kòmantè jiskaske reyinyon Konsèy la rive

Nou aksepte kòmantè ak odyans piblik nan Komisyon Zonaj la

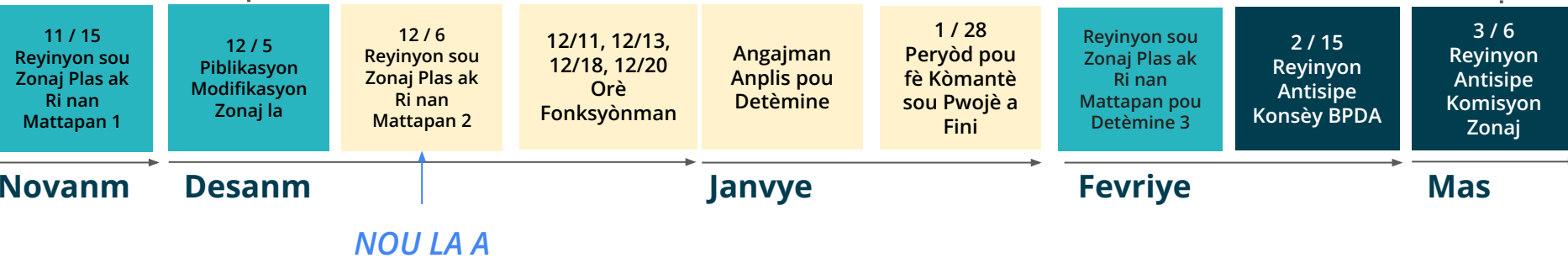

## Plas ak Ri nan Tout Vil la (Amandman Tèks)

Peryòd pou fè Kòmantè sou Pwojè a

Nou aksepte kòmantè jiskaske reyinyon Konsèy la rive

Nou aksepte kòmantè ak odyans piblik nan Komisyon Zonaj la

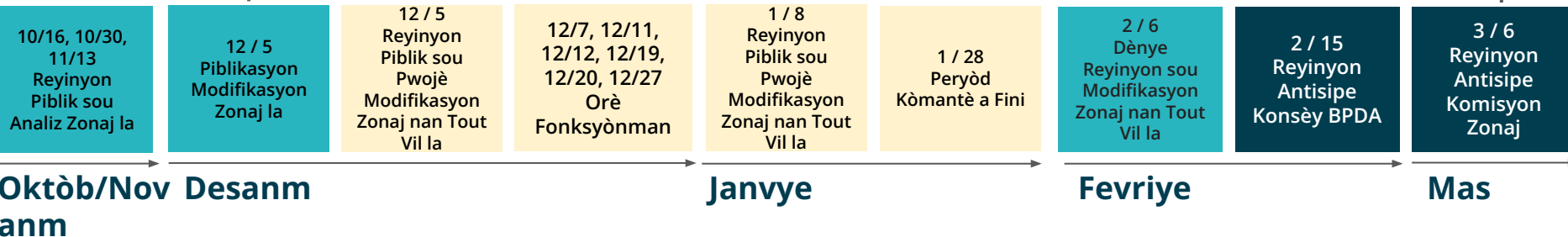

# Zonaj Rezidansyèl

---

**Adriana Lasso-Harrier** - Ibanis, BPDA





**Soti nan Plan pou Katye  
rive nan Nouvo Zonaj  
Rezidansyèl**

# Chanjman zonaj yo ap sèlman aplike pou PLAN an: Zòn Etid Mattapan anndan Distri Zonaj Gran Mattapan

PLAN: Mattapan te gen yon zòn etid espesifik rekòmandasyon nan zafè planifikasyon li yo te aplike pou li.

Distri Zonaj Gran Mattapan an (sifas atik 60 lan kontwole) depase zòn etid sa a.

- Y ap aplike nouvo soudistri zonaj ak dimansyon yo sèlman nan **limit zòn etid** la
- Y ap fè divès chanjman nan tèks la, men yo p ap kreye okenn nouvo règ sou zonaj. Chanjman sa yo ap reflete nan **Atik 60** lan

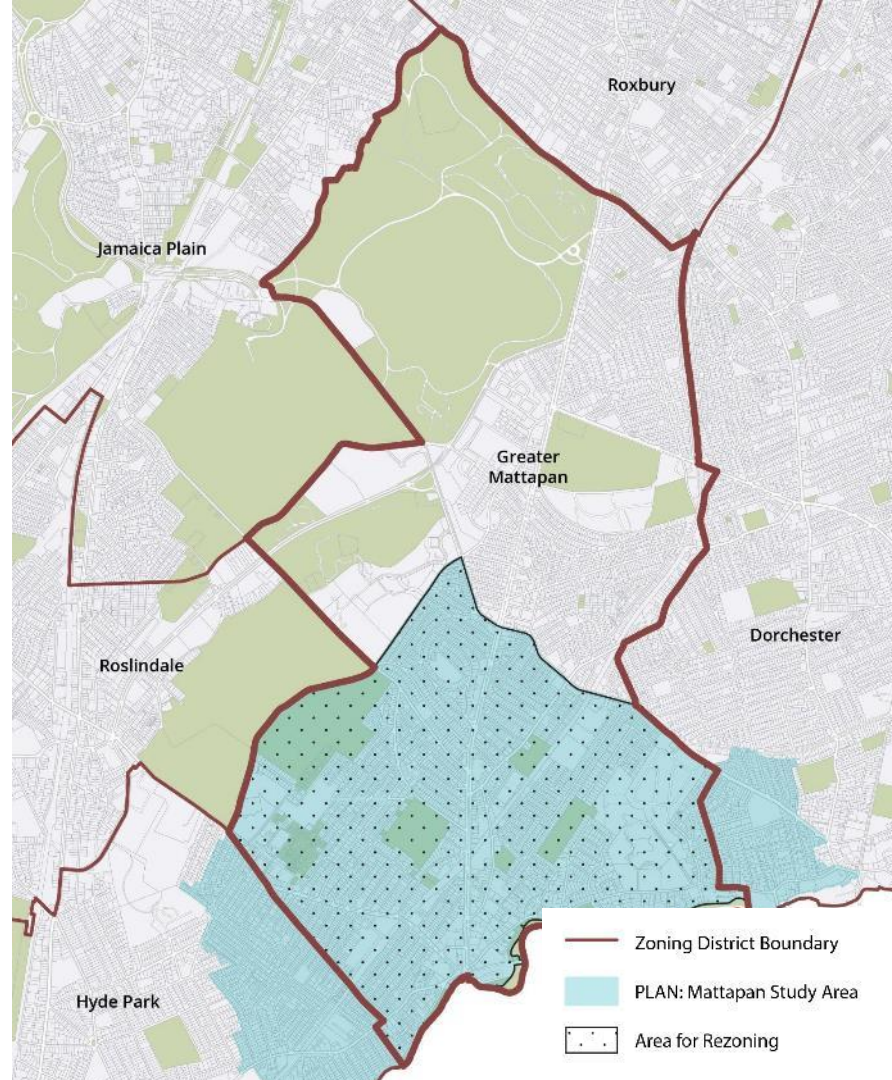

# Objektif la: Yon Kòd Zonaj Pwogresif epi Senplifye

Modifikasyon tèks yo ap modènize zonaj rezidansyèl Mattapan an, sa ki vle di nouvo tèks yo ap adapte pi byen avèk kay ak bilding ki deja la yo.

Nou kapab klase chanjman zonaj yo nan twa (3) kategori:

1. Nouvo zonaj rezidansyèl k ap **pèmèt katye a kontinye a egziste ak rete bèl** gras ak renovasyon ki fèt nan kay ki la deja yo ak konstriksyon nouvo lojman ki adapte ak zòn nan sou teren ki vid
2. Nouvo zonaj rezidansyèl ki pral pèmèt moun **konstui Inite Lojman Siplemanchè san yo pa bezwen pèmisyon pou sa** sou tout teren nan Mattapan.
3. Divès modifikasyon tèks nan Atik 60 ki **amelyore fonksyon kòd la**



*Ou jwenn anpil kay tankou kay sa yo nan Mattapan. Men, akòz zonaj la ki ansyen, yo souvan vyole youn oswa plizyè règlezonaj.*

# Objektif la: Yon Kòd Zonaj Pwogresif epi Senplifye

Chanjman yo pwopoze ki pou fèt nan kòd rezidansyèl Mattapan nan ap asire zafè zonaj la fyab epi fasil pou konprann, epi pèmèt konstriksyon lojman k ap reponn ak bezwen rezidan yo pandan lontan.

Men ki jan pwojè zonaj rezidansyèl la ap ye:

- **Pi fasil pou li ak itilize:** li ap di nan yon langaj ki senp ki konstriksyon ki kapab fèt epi ki kote l ap fèt
- **Li ap reflete valè Mattapan yo:** pwopoze diferan kalite lojman pou reponn ak bezwen diferan kalite fanmi ak egzijans yo (ADU yo, konstriksyon nan yon manyè ki ale byen avèk katye ki la deja a)
- **Modèn epi fyab:** li ap kadre avèk kalite bilding ak teren ki la deja yo
- Li ap gen ladan l nouvo règ sou dimansyon ki vize rann bilding yo pi rezistan fas ak **chanjman klima** yo epi konsidere **gwosè teren** yo

## Housing

Boston's housing shortage means that new housing must be built in all neighborhoods, thereby easing high demand and stabilizing housing prices. PLAN: Mattapan's recommendations for housing are twofold. First, ensure that all existing Mattapan residents have the resources and support they need in order to stay in their homes and neighborhood. Second, increase the neighborhood's housing supply (and therefore ease demand and competition for current housing stock in Mattapan).

*Nan PLAN an: Rekòmandasyon pou Sektè Rezidansyèl nan Mattapan (paj 60)*



# Kontwòl Dirèk sou Fòm ak Dansite Bilding yo

Zonaj yo pwopoze a ap ranplase *Rapò Sipèfisi* a avèk yon *Kouvèti Maksimal Sifas Teren*, sa ki ap fasilite kontwòl sou fòm ak gwosè bilding yo.

***Kouvèti Sifas Teren.*** Se Sipèfisi Teren pi gwo Plan Bilding chak bilding ki sou teren an okipe. Ladan li pa genyen bilding detache ki gen yon etaj ki pa bezwen pèmi konstriksyon tankou tiabri pou mete zouti oswa pou estokaj, kay jwèt, elatriye.

- Eksplike sa k ap pase a nan yon manyè ki senp → **diferans ant espas ak bilding**
- Amelyore bagay yo pou moun yo → **Fason moun yo wè bilding yo sou yon teren**
- **Zouti ki pi senp epi ki fasil** pou itilize epi ki bay rezilta yo ap tann lan **yon fason ki pi fyab pandan devlopman** an
- **Li ajiste** selon gwosè teren an ak kalite pwojè konstriksyon an

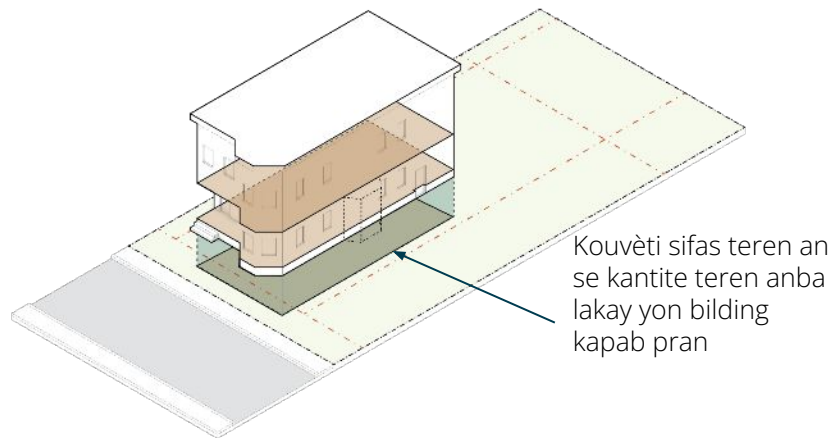

# Fason pou Rekonèt Gwosè Teren an

**Zonaj aktyèl** kontwole gwosè ak dimansyon pasèl teren rezidansyèl yo. Epitou, li genyen règ ki gen pou wè ak dimansyon (egzijans nan zafè lakou, rapò sifas atè a) ki souvan pa kadre avèk konstriksyon ki fèt la.



# Fason pou Rekonèt Gwosè Teren an

Zonaj yo pwopoze a ap genyen diferan dimansyon selon gwosè teren an epi si pwojè a genyen yon ADU oswa si l pa genyen.



*Sipèfisi tèren an: 5,723 pye kare  
Anpwent bilding nan: 1,200 pye kare, kay  
pou de (2) fanmi  
Kouvèti sifas teren an: 22%*



*Sipèfisi tèren an: 3,253 pye kare  
Anpwent bilding nan: 1,200 pye kare, kay  
pou yon (1) fanmi  
Kouvèti sifas teren an: 39%*

# Rezilyans Klimatik nan Zonaj

Zonaj yo pwopoze a ap ranplase *Minimòm Espas Ouvè* yo avèk yon *Minimòm Sifas nan Teren an ki Kapab Absòbe Dlo*, pandan li fikse objektif rezilyans klimatik yo nan zonaj la.

*Sifas nan Teren an ki Kapab Absòbe Dlo. Se Sifas nan Teren an yon kouvèti vejetal natirèl kouvri oswa nenpòt materyèl/bagay ki atè a ki pèmèt dlo pase nan yon to oswa kantite ki egal ak kouvèti vejetal natirèl la oswa ki pi plis pase li.*





**Nouvo Zonaj pou Kore  
Renovasyon ak Nouvo  
Konstriksyon sou Teren  
Vid**

# Zonaj ki La Deja a

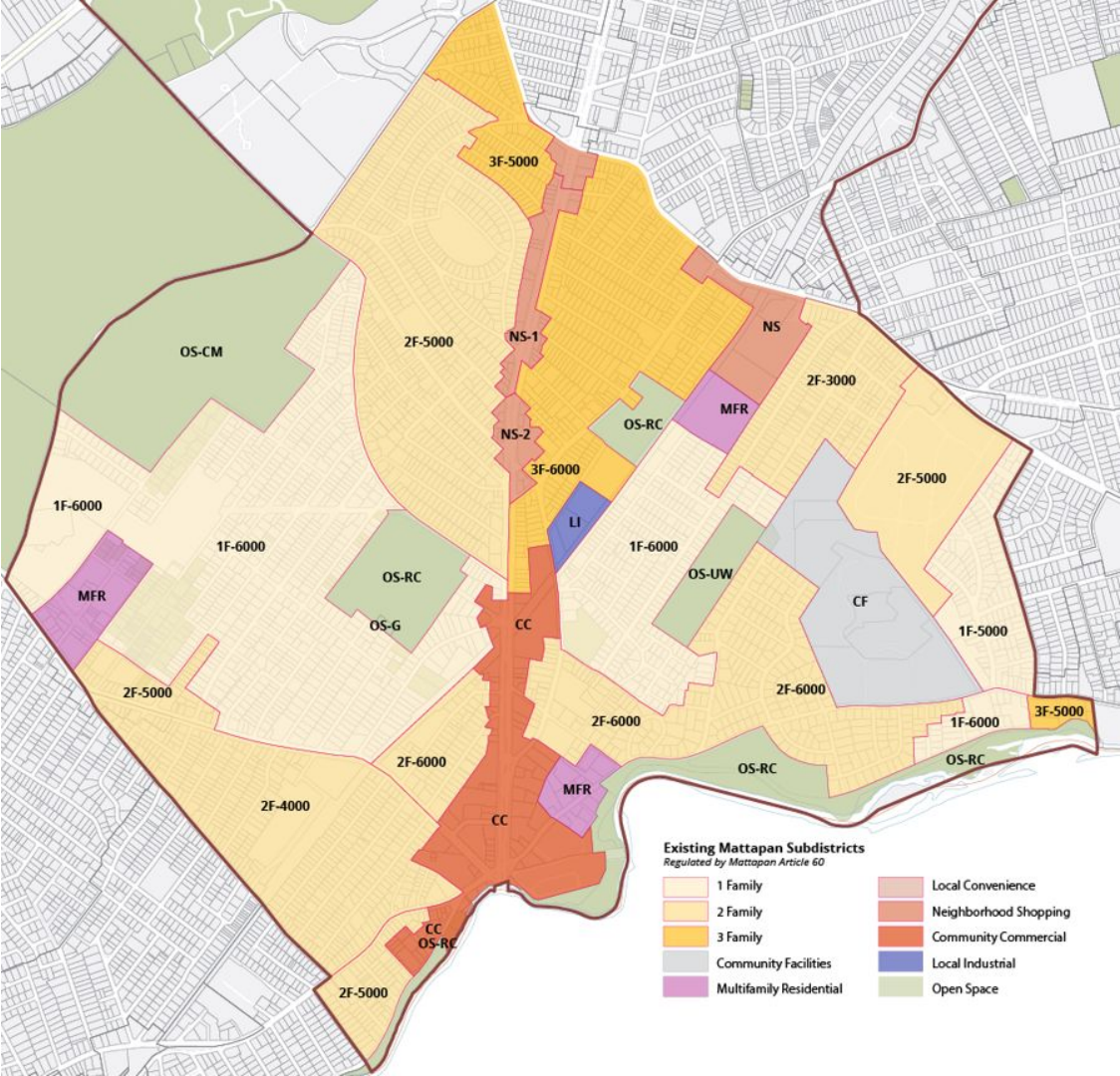

# Soudistri Rezidansyèl yo Pwopoze

- **Soudistri Rezidansyèl-1 (R1)** ak **Soudistri Rezidansyèl-2 (R2)** – nouvo soudistri rezidansyèl pou Mattapan
- **Distri MFR ki la yo ap rete,** avèk kèk sifas yo ajoute pou legalize kay pou plizyè fanmi ki deja la yo.

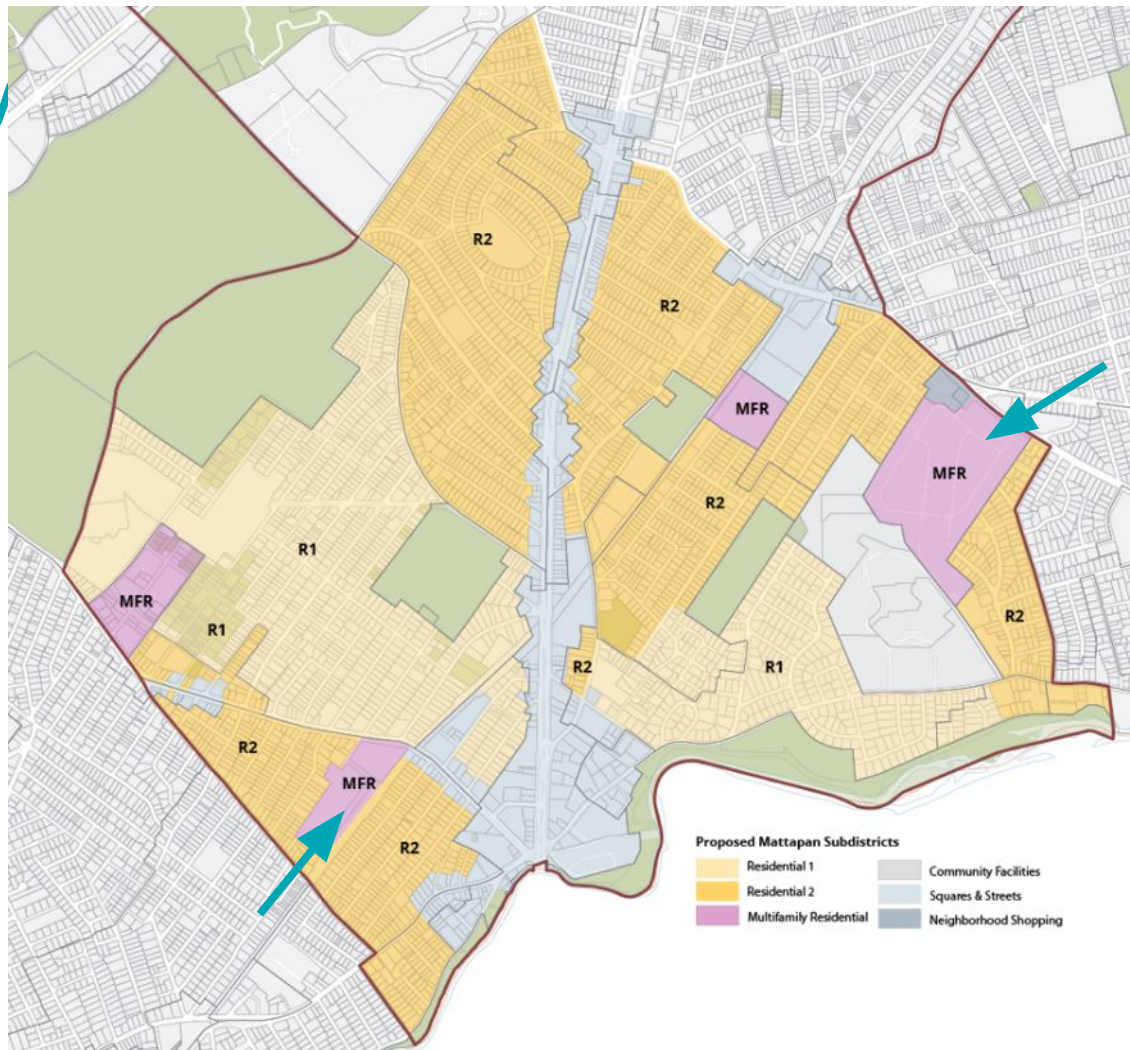

# Kore Devlopman Lojman Kontekstyèl

Toude soudistri yo pwopoze chanjman ki pral pi byen aliyen zonaj la avèk konstriksyon ki deja fèt yo.

## Rezidans-1 (R1)



- Jiska 2 inite lojman, ki pa gen ADU ladan yo
- Nouvo zonaj la legalize sa ki deja la yo
- Nouvo konstriksyon sou teren vid yo ap koresponn ak sa ki ozalantou yo

## Rezidans-2 (R2)



- Jiska 3 inite lojman, ki pa gen ADU ladan yo
- Nouvo zonaj la legalize sa ki deja la yo
- Nouvo konstriksyon sou teren vid yo ap koresponn ak sa ki ozalantou yo



# Zonaj Debaz yo Pwopoze pou R1 ak R2

Yo pwopoze 2 soudistri rezidansyèl:

- **Rezidansyèl-1 (R1)** ki ap pèmèt konstriksyon **jiska 2 inite lojman** sou chak teren.
- **Rezidans-2 (R2)** ki ap pèmèt konstriksyon **jiska 3 inite lojman** sou chak teren.

Kouvèti Sifas Teren pou teren ki mwens pase 5000 pye kare	Kouvèti Sifas Teren pou teren ki plis pase oswa ki egal ak 5000 pye kare	Sifas Minimòm nan Teren an ki Kapab Absòbe Dlo	Minimòm Lakou Devan	Minimòm Lakou sou Kote	Minimòm Lakou Dèyè	Wotè Maksimòm Bilding nan (Etaj / Pye)	Fasad Minimòm Bilding nan
40%	30%	25%	10 pye	14 pye antou, 3 pye minimòm	20 pye	3 / 35 pye	20 pye

# Soudistri Rezidansyèl-1: Konstriksyon Kay sou Teren Vid ak Renovasyon

Nan zonaj yo pwopoze a ap genyen konstriksyon nouvo bilding ki gen jiska 3 etaj epi ki kapab pran maksimòm 2 inite lojman. Nouvo ADU yo kapab pote gwo avantaj nan 3 inite lojman pou pi plis.

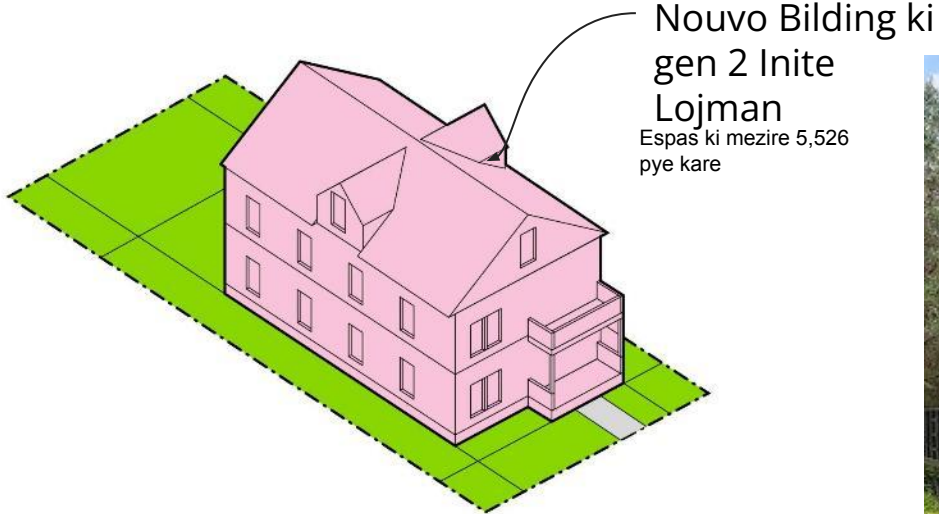

Sipèfisi tèren an: **4,510 pye kare**  
Anpwent bilding nan: **1,804 pye kare**

Kouvèti Sifas Teren an: **≤40%**  
Sifas ki kapab absòbe dlo: **≥25%**



# Soudistri Rezidansyèl-2: Konstriksyon Kay

Nan zonaj yo pwopoze a ap genyen konstriksyon nouvo bilding ki gen jiska 3 etaj epi ki kapab pran maksimòm 3 inite lojman. Nouvo ADU yo kapab pote gwo avantaj nan 4 inite lojman pou pi plis.

Yon (1) Pakin  
pou Chak Inite  
Lojman

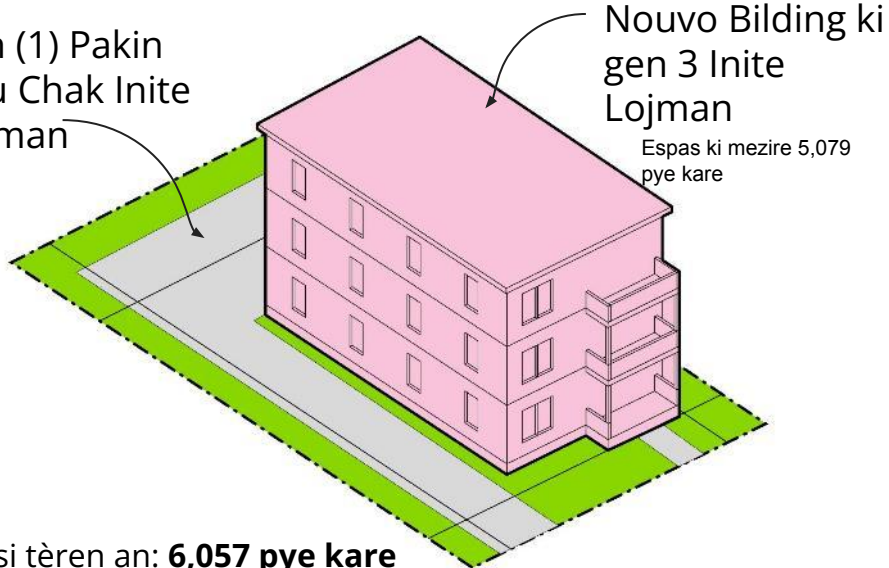

Sipèfisi tèren an: **6,057 pye kare**  
Anpwent bilding nan: **1,695 pye kare**

Kouvèti Sifas Teren an: **28%**  
Sifas ki kapab absòbe dlo: **≥25%**





# Nouvo Zonaj pou Kore Inite lojman Sipleman yo



# Zonaj yo pwopoze a Ap Pèmèt Genyen ADU sou Pifò Teren

Zonaj yo pwopoze a ap rann li pi fasil pou konstui diferan kalite ADU nan Mattapan san pèmision espesyal.

- Genyen **18** ADU anndan yo otorize oswa konstui nan Mattapan depi 2018 (ak anviwon **150** nan tout vil la).
- **Moun yo oblije viv nan kay yo achte**
- P ap gen **okenn egzijans nan zafè pakin** pou ADU yo.



mayorwu 🌟 Mark is a Roxbury homeowner who built an additional dwelling unit (ADU) to give his mother a safe and accessible place to live. Thanks to her new ADU, Mark's mother will be able to be close to her son and have her independence at home.

## Reyaksyon fas ak Sa Kominote a Di:

- Chèche fason pou jwenn lajan
- Kontakte plis moun nan voye anvlòp lapòs
- Rapò fen ane sou pèmi konstriksyon yo
- Kolaborasyon avèk ISD



# Kore Konstriksyon ADU Pwopriyetè yo Ap Dirije

## Inite lojman Siplemanchè ki Pa Detache

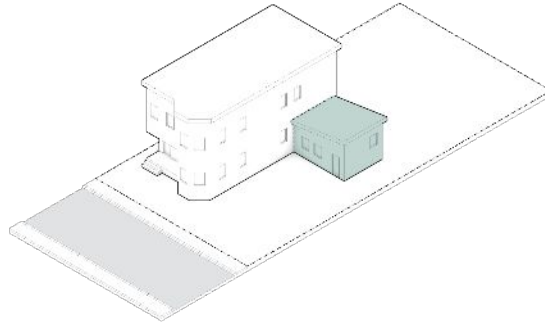
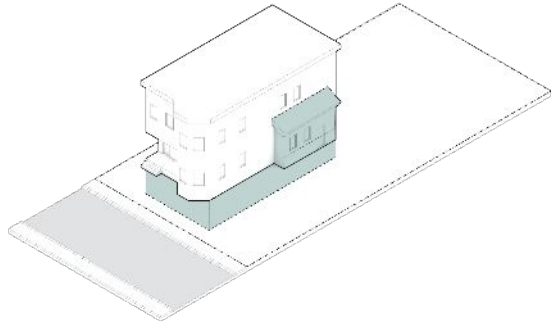

- Ajoute sou kay ki la deja a
- Posiblite pou itilize espas ki la deja a oswa kreye ADU avèk nouvo konstriksyon an, oswa toude
- Posiblite pou konstui jiska **yon ADU ki pa detache**

## Inite lojman Siplemanchè ki Detache

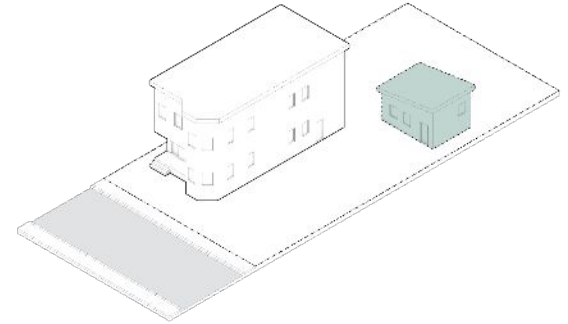

- Estrikti ki pi piti epi ki separe nèt
- Nouvo konstriksyon oswa renovasyon sa ki la deja yo
- Posiblite pou konstui jiska **yon ADU ki detache**

# Zonaj yo Pwopoze pou ADU yo

Tablo dimansyon sa a ap sèlman valab lè pwopriyetè kay yo ap konstui yon ADU.

Kouvèti Sifas Teren pou teren ki mwens pase 5000 pye kare	Kouvèti Sifas Teren pou teren ki plis pase oswa ki egal ak 5000 pye kare	Sifas Minimòm nan Teren an ki Kapab Absòbe Dlo	Minimòm Lakou Devan	Minimòm Lakou sou Kote	Minimòm Lakou Dèyè	Wotè Maksimòm m Blding nan (Etaj / Pye)	Fasad Minimòm Teren an
60%	50%	15%	5 pye	3 pye	20 pye	Eтаж ki deja la yo se plis pase 1	20 pye

\* Inite Lojman Sipleman tè ki Pa Detache yo ak sila yo ki detache dwe respekte règ dimansyon yo endike nan Atik 2 a tou

\*\* Yo ka konstui Inite lojman Sipleman tè ki Detache yo nan lakou dèyè a

# ADU ki Pa Detache

## Inite lojman Siplemanchè ki Pa Detache

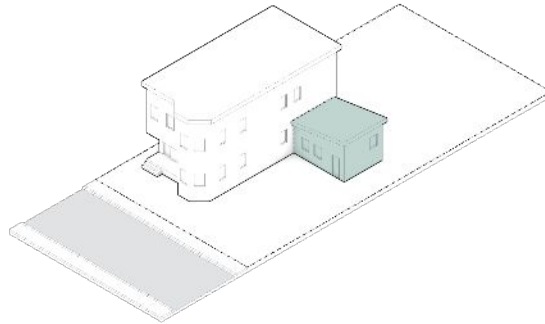
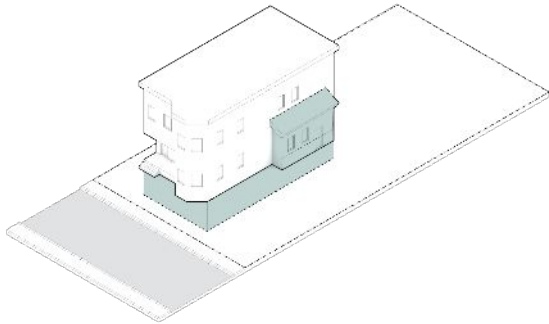

- 75% nan sipèfisi inite lojman prensipal la oswa 1250 pye kare, kèlkeswa sa ki pi piti a
- Wotè nouvo konstriksyon yo pa kapab depase wotè estrikti prensipal la
- Epitou, li dwe reponn ak egzijans nan zafè zonaj





# ADU ki Pa Detache

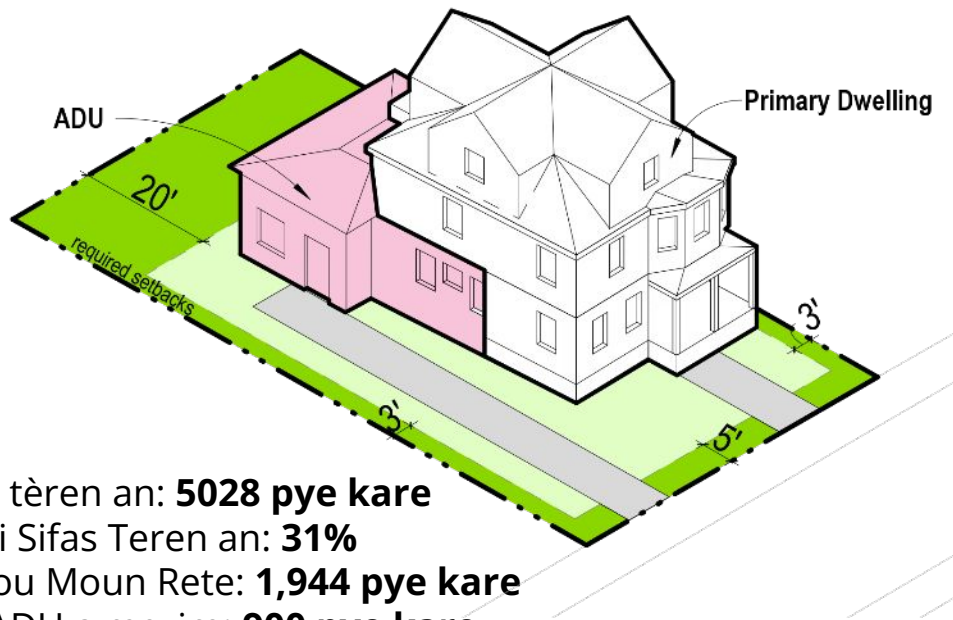

Sipèfisi tèren an: **5028 pye kare**  
Kouvèti Sifas Teren an: **31%**  
Sifas pou Moun Rete: **1,944 pye kare**  
Espas ADU a mezire: **900 pye kare**  
Sifas ki kapab absòbe dlo: **>15%**

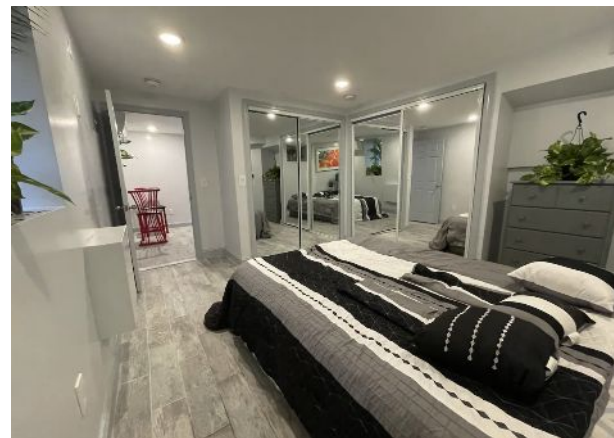

*Foto yon ADU yo konstui nan anba lakay an 2019 nan Mattapan.*

# ADU ki Detache

## Inite lojman Siplemanchè ki Detache

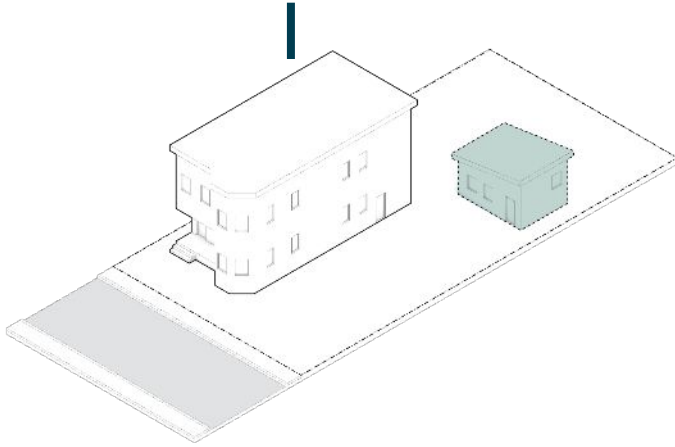

- Plan bilding ki mwens pase oswa ki egal ak 900 pye kare oswa ki gwosè plan estrikti prensipal la, nenpòt sa ki pi piti a
- Wotè a ka yon (1) etaj edmi ( $\frac{1}{2}$ ) oswa wotè estrikti prensipal la, nenpòt sa ki pi piti a
- Fòk li nan yon distans ki omwen 5 pye ak lòt bilding ki sou teren an
- Epitou, li dwe reponn ak egzijans nan zafè zonaj



# ADU ki Detache

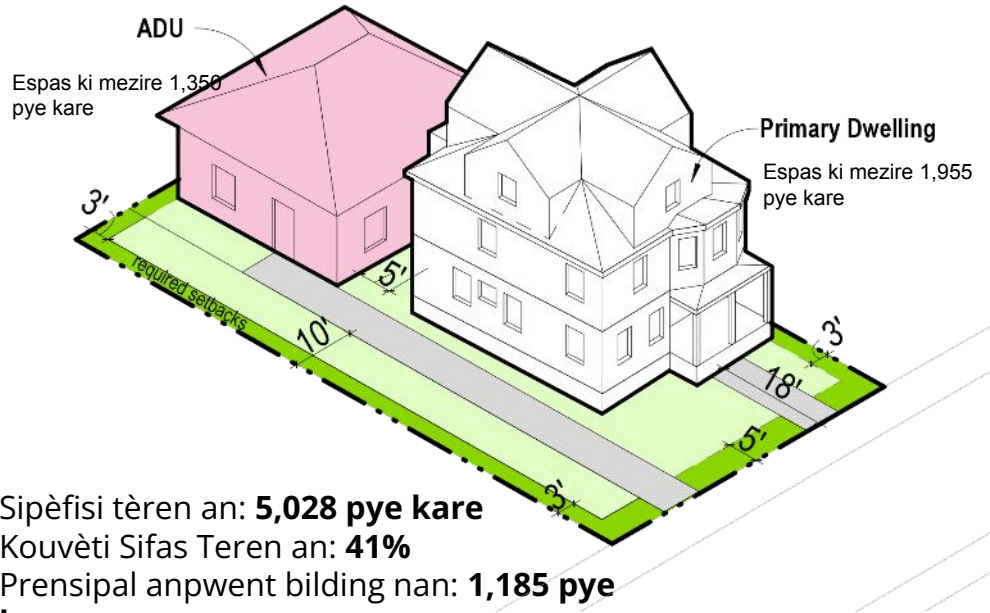

Sipèfisi tèren an: **5,028 pye kare**  
Kouvèti Sifas Teren an: **41%**  
Prensipal anpwent bilding nan: **1,185 pye kare**  
Anpwent bilding ADU a: **900 pye kare**  
Sifas ki kapab absòbe dlo: **>15%**



*ADU ki detache yo fè tounen remiz ki mezire 400 pye kare nan Roxbury*

# Senaryo Egzanp

## Soudistri Rezidansyèl-1

Li otorize jiska 3 inite lojman antou, ki gen  
ADU

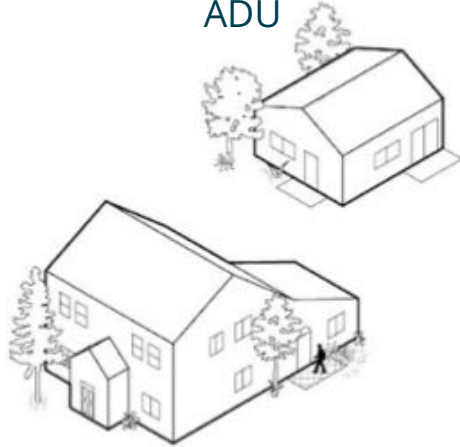

**Kay pou Yon Sèl Fanmi ki gen 2  
ADU  
(3 inite lojman antou sou teren  
an)**

*Pwopriyetè kay sila a ki pou yon sèl fanmi agrandi  
premye etaj la pou l fè yon ADU ki pa detache. Apresa,  
li fè remiz li an tounen yon ADU ki detache.*

## Soudistri Rezidansyèl-2

Li otorize jiska 4 inite lojman antou, ki gen  
ADU

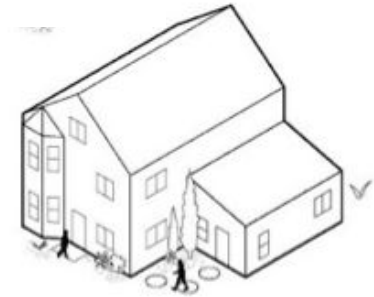

**Kay pou Twa (3) Fanmi ki gen yon  
(1) ADU  
(4 inite lojman antou sou teren  
an)**

*Pwopriyetè kay sila a ki pou twa (3) fanmi ajoute yon  
ADU ki pa detache nan kay li a.*

# Sipò pou Pwopriyetè yo

---

*Marcy Ostberg - Biwo Majistra pou zafè Lojman*

# Bay pwopriyetè yo plis sipò

Minisipalite a pran angajman pou li ede pwopriyetè yo lè yo ap konstui ADU yo

KOUNYE A

## KONSÈY

- **Atelye konsepsyon** reyinyon chak mwa pou pwopriyetè yo kapab jwenn enfòmasyon sou plan yo a nan men manm pèsònèl minisipalite a

## FINANSMAN

- Boston Home Center **prè \$50,000** pou kèk pwopriyetè ki ranpli kondisyon revni yo

## PWOSESIS

- **ADU Toolkit** se yon resous anliy ki dekri règleman, pwosesis ak finansman [www.boston.gov/adu-toolkit](http://www.boston.gov/adu-toolkit)

2024

- Gen **Konsèy sou Kòd** konstriksyon ADU yo ak sekirite kont ensandi ki disponib nan lyen sa a <https://www.bostonplans.org/getattachment/630740a5-123c-40dc-84f7-5f06a3ee31e8>

- Nouvo **pwodui finansman** espesifik pou ADU ki fèt avèk gwoup travay pretè yo

- **Kowòdonatè ADU** k ap kowòdone **asistans teknik** pou pwopriyetè ki elijib pou revni

# Konsèy sou Kòd restriksyon ADU yo ak Sekirite kont Ensandi

Plizyè sèvis te pote kole pou yo etabli règ ki vize pwoteje ADU yo kont ensandi. Règ sa yo panche sou kòd restriksyon ak prevansyon ensandi. Men sou ki sijè yo te pale:

- Wout Aksè pou Ponpye,
- Ti aparèy dlo pou etenn dife, ak
- Rezistans fas ak dife
- *YO PA PALE SOU: zonaj*

## Objektif dokiman oryantasyon an:

- **Pwopriyete yo kapab detèmine si l posib pou** yo ajoute yon ADU **epi konbyen l ap koute**. Fòk yo konnen sa yo kapab fè ak sa yo pa kapab fè
- **Pwofesyonèl yo kapab ede pwopriyete yo fè plan** epi konstui yon ADU ki reponn ak tout egzijans yo
- **Anplwaye minisipal yo bay enfòmasyon** sou pwosesis ak egzijans pou ADU yo

## Senaryo Oryantasyon: Fasad 10-20 pye yon ADU ki detach

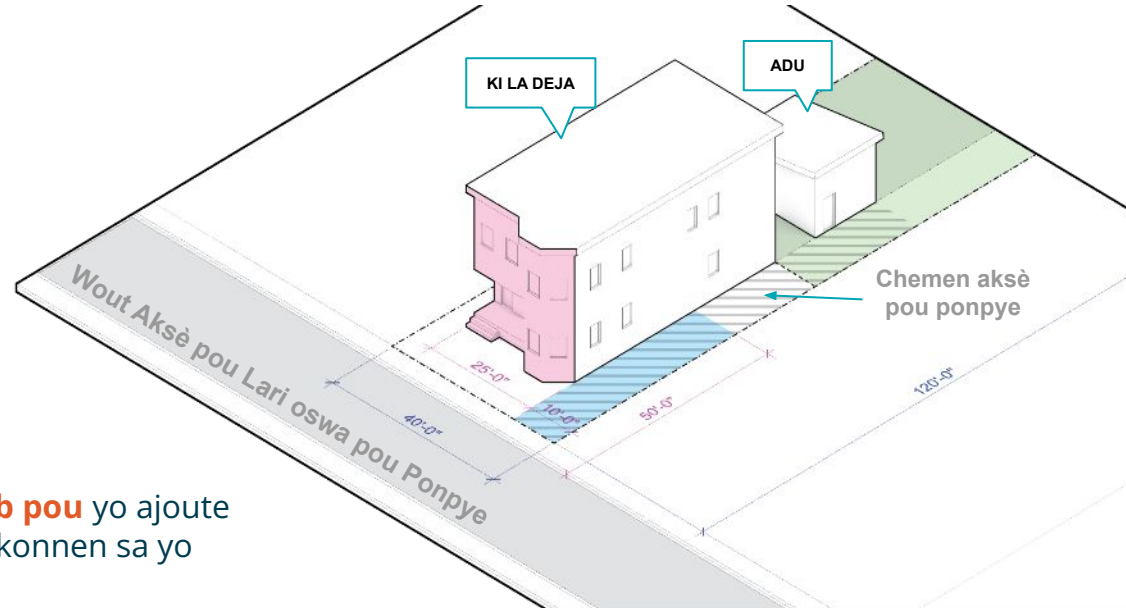



**Modifikasyon Tèks pou  
Amelyore Fonksyon Atik  
60 lan**



# Egzijans Minimòm pou Pakin ak Modifikasyon Tèks

**Pou rann tèks la fasil pou li, nouvo plan zonaj la pwopoze pou regwoupe enfòmasyon ki repete yo nan Atik 60 lan epi fè gwo modifikasyon nan seksyon sa yo nan Atik la:**

- Seksyon 60-1. Deklarasyon Objektif, Limit Fizik, ak Enpòtans li
- Seksyon 60-5. Entèdiksyon Zòn Devlopman ki Planifye yo
- Seksyon 60-6. Patisipasyon Kominote a
- Seksyon 60-2. Etablisman Soudistri Rezidansyèl yo
- Seksyon 60-4. Règleman Dimansyon ki Aplikab nan Soudistri Rezidansyèl yo
- Seksyon 60-11. Etablisman Soudistri Espas Ouvè yo
- Seksyon 60-31. Evalyasyon Konsepsyon ak Direktiv nan zafè Konsepsyon
- Seksyon 60-36. Aplikasyon Egzijans Dimansyon yo



**Egzijans minimòm pou pakin yo te aliyen avèk politik Depatman Transpò nan Boston genyen kounye a, ki te detèmine direktiv rapò pakin minimòm pou tout zòn nan Boston.**

# Modifikasyon ki nan Tablo Itilizasyon

Yo chanje tablo itilizasyon pou soudistri rezidansyèl yo pou yo relete rekòmandasyon ki fèt pou planifikasyon an.

	Rezidans-1 (R1) ak Rezidans-2 (R2)	Rezidans pou Plizyè Fanmi
<b>Yo Fenk Otorize</b>	Etablisman ki Bay Swen, Moun Aje Inite Lojman Sipleman tè, ki Detache Inite Lojman Sipleman tè, ki Pa Detache	Etablisman ki Bay Swen, Moun Aje
<b>Yo Fenk Otorize sou Kondisyon</b>	Sant Kominotè	Pa Aplikab

Yo modifiye epi senplifye tablo itilizasyon yo nan Atik 60 lan pou rann yo pi efikas.

Yo Retire	Yo Fizyone
Sal Biya Santral Telefòn Kabin Telefòn ou Peyè ki Deyò Òfelina	Mize, Espas Atistik/Ekspozisyon Piblik → Espas Ekspozisyon Atistik, tankou Galri, Mize

# Modifikasyon Zonaj pou White Stadium



White Stadium nan Franklin Park, yo te klase oparavan nan soudistri OS-Parkland (OS-P), te klase ankò nan soudistri OS-Recreation (OS-RC). Chanjman sa a te fèt pou reflete itilizasyon estad la ki deja egziste e ki alavni pral sèvi kòm yon etablisman espò ak lwazi.

Ap genyen yon reyinyon piblik vityèl jou k ap mèkredi 19 desanm nan pou pale sou zonaj Espas Ouvè ak White Stadium, men nou te vle mete aksan sou sa piske li nan kat zonaj Atik 60 lan.

# Pwosesis ak Kalandriye Zonaj Rezidansyèl la

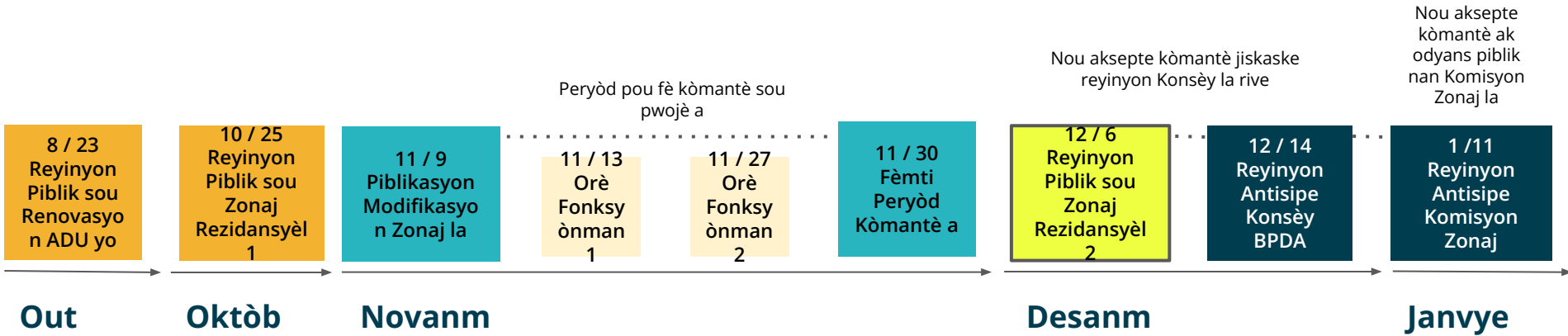

# Plas ak Ri

Jack Halverson, Ibanis, BPDA



# Men Sa Nou Te Pataje Dènye Fwa (Reyinyon 15 novanm nan)

1

Fonksyonman  
zonaj la ak sa li  
kapab fè pou  
fè avanse  
PLAN:  
Mattapan

2

**Règleman ak  
vizyon** pou  
distri ki gen  
Plas ak Ri yo

3

**Kote yo ka  
aplike nouvo  
zonaj** nan Plas  
ak Ri nan  
Mattapan

4

Fason ou  
**kapab fè  
kòmantè**, rete  
enfòme, epi  
kontribiye nan  
elaborasyon  
zonaj sa a

# Men Sa Nou Te Pataje Dènnye Fwa (Reyinyon 15 novanm nan)

Eksplike fason Zonaj S+S la fè **PLAN** an avanse:  
**Rekòmandasyon Mattapan** nan chak ti zòn.

**Mattapan Square**

**PLAN: Mattapan Recommendations**

- Request mixed-use and commercial development
- FAR to 4.5, height to 70 feet, setbacks in upper stories
- Uplift cultural identities through businesses + spaces
- Set coverage requirements to allow for street trees

**Morton Street Station**

**PLAN: Mattapan Recommendations**

- Expansion of ground floor commercial uses
- FAR to 1.75, height to 55 feet, rear yards to transition
- Create an anchor within residential areas
- Include front yard setbacks to allow for street trees

Eksplikasyon rezònman dèyè **katografi chak distri zonaj** nan chak ti zòn.

**Mattapan Square**

**Blue Hill Ave Station**

**Cummins & Greenfield**

**Morton Street Station**

# Men Sa N ap Pataje Aswè a

1

**Règleman sou dimansyon ak itilizasyon tè** espesifik pou chak Distri Zonaj Plas ak Ri

2

**Metodoloji ak analiz** pou devlope Distri Zonaj Plas ak Ri

3

**Fason pou li amandman tèks ak kat** zonaj yo pwopoze a

4





Fason ou **kapab fè kòmantè**, rete enfòme, epi kontribiye nan elaborasyon zonaj sa a





# Plan Plas ak Ri Distri Zonaj yo

# Distri Plas ak Ri

S0	S1	S2	S3	S4
				
<p><b>Lojman Pwovizwa</b></p>	<p><b>Aktivite nan Ri Prensipal</b></p>	<p><b>Ri Prensipal Itilizasyon Miks</b></p>	<p><b>Ri Prensipal ki Gen Anpil Aktivite</b></p>	<p><b>Plas ki Gen Anpil Aktivite</b></p>
<ul style="list-style-type: none"> <li>• Tranzisyon ant ri ak plas kote ki gen ti aktivite ak gwo aktivite yo</li> <li>• Rezidansyèl ak siplemantè sèlman</li> <li>• Chantye ki nan nivo travay k ap fèt la</li> </ul>	<ul style="list-style-type: none"> <li>• Nou otorize vitrin ki pa twò wo devan lokal biznis yo avèk itilizasyon ki limite</li> <li>• Prensipalman rezidansyèl</li> <li>• Chantye ki pa twò gwo</li> </ul>	<ul style="list-style-type: none"> <li>• Konstriksyon ki fèt yon fason ki pwòch nan Mainstreet, men ki gen yon kouvèti teren ki pi fèb epi ki egzije lakou, jaden oswa plas</li> <li>• Fòk gen divès biznis oswa aktivite nan anba lakay la, soti nan piti rive nan mwayen</li> </ul>	<ul style="list-style-type: none"> <li>• Konstriksyon ki fèt yon fason ki pwòch nan Mainstreet</li> <li>• Rezidans oswa ti aktivite otèl</li> <li>• Fòk yo itilize l pou fè aktivite</li> <li>• Kouvèti teren an koresponn ak gwosè tè a</li> </ul>	<ul style="list-style-type: none"> <li>• Yon pi gwo kantite etaj anlè yo itilize pou divès aktivite</li> <li>• Itilizasyon anba lakay ki yon tjan gwo oswa ki gwo anpil yo pou fè aktivite</li> <li>• Kouvèti teren an koresponn ak gwosè tè a</li> </ul>

# Sa ki pataje nan chak distri?

- **Limite anpwent bilding nan ak lajè li** pou nou kapab pi byen montre echèl ki gen nan konsepsyon iben an
- Li gen ladan l **kouvèti maksimòm sifas teren** an ak **sifas minimòm nan teren an ki kapab absòbe dlo** pou detèmine pwochen devlopman an
- **Fikse dimansyon pou lakou yo kote yo enpòtan,** tankou lakou dèyè yo pi gwo nan zòn ki pre zòn rezidansyèl yo



# Sa nou pataje nan chak distri?

- Bay **ti pwojè yo** menm **libète pakin ak gwo pwojè yo** nan siprime egzijans minimòm pou pakin epi **modènize egzijans yo nan zafè chajman** (S0-S4)
- Kreve pi bon espas pou moun viv pandan n ap egzije **amenajman espas kote ki deyò** yo tankou balkon, teras, lakou ki anba kay, peyizaj lari, ak plas yo (S2-S4)
- Kreve yon peyizaj ki montre gen lavi nan ri a, pandan n ap egzije yon kantite **itilizasyon ki aktif nan anba lakay la**. Epitou, li limite kantite **“mi vid”** san fenèt nan anba lakay la



# Ki diferans ki genyen ant chak distri?



## Itilizasyon

- Itilizasyon anba lakay la pa rapò ak itilizasyon etaj ki anwo a (oswa gwosè maksimòm an jeneral)
- Si yo mande pou gen aktivite ki fèt nan anba lakay la

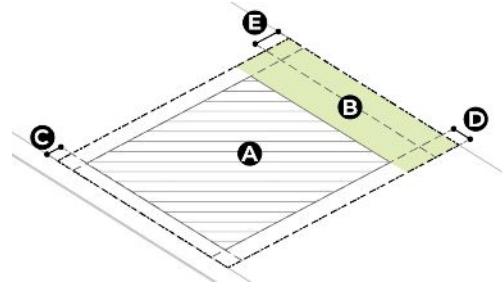

## Estanda ki gen rapò ak Teren

- Kouvèti sifas teren an
- Gwosè lakou devan, dèyè ak sou kote
- Sifas nan teren an ki kapab absòbe dlo

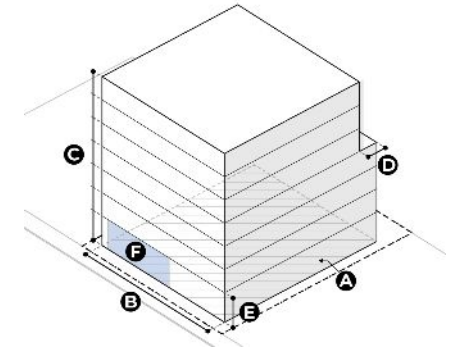

## Fòm Bilding nan

- Plan bilding nan
- Lajè maksimòm bilding nan
- Wotè maksimòm bilding nan ak etaj yo
- Kònich dèyè

# Pase Men nan Règleman sou Dimansyon yo pou Konsantre sou Fòm

Jodi a ( <i>Zonaj Distri Komèsyal nan Mattapan</i> )	Pwopozisyon ( <i>Zonaj Plas ak Ri</i> )
<b>Rapò Sifas Maksimòm Atè a (Floor Area Ratio, FAR)</b>	Kouvèti Sifas Teren an
Minimòm Espas Ouvè yo Kapab Itilize pou chak Inite Lojman (an pye kare)	Sifas Maksimòm Atè Bilding nan
Lakou Devan Minimòm	Lakou Devan Minimòm
Wotè Maksimòm Bilding nan (an pye)	Lakou Dèyè Minimòm
	Lakou sou Kote Minimòm
	Sifas nan Teren an ki Kapab Absòbe Dlo
	Lajè Maksimòm Bilding nan
	Wotè Maksimòm Bilding nan (an pye ak etaj)
	Kònich nan Etaj Anwo

# Distri S-0: Lojman Pwovizwa

Ti distri rezidansyèl ki ofri yon tranzisyon kote nou soti nan ri ak plas yo itilize pou plizyè bagay epi ki gen anpil aktivite, pou pase nan zòn rezidansyèl ki pa gen anpil aktivite.

## Itilizasyon

- Yo ka itilize zòn sa yo pou kay sèlman; gen limit sou gwosè bilding yo selon règ ki nan sou atik 80 an

## Fòm

- Tranzisyon nan “kwen lari a” pou rive nan rèz katye a; epi yo mete sou kat la sou moso tè ki pi piti yo
- Ti sifas maksimòm pou atè bilding nan
- Egzijans yo fè pou lakou devan ak lakou sou kote yo prevwa pou gen espas pou pyebwa, yon ti kouvèti kote gen pyebwa pou teren an, ak yon egzijans maksimòm pou zòn ki kapab absòbe dlo

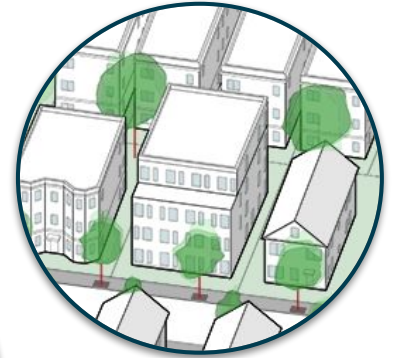

*Espas lakou devan ki pi gwo*



*Fòk gen yon pousantaj nan lakou a ki kapab absòbe dlo, tankou avèk gazon oswa plant*

# Distri S-0: Lojman Pwovizwa

Estanda ki gen rapò ak Teren	
Kouvèti Sifas Teren an	60%
Lakou Devan	8 pye minimòm
Lakou Dèyè	15 pye minimòm
Lakou sou Kote	14 pye antou (3 pye minimòm)
Sifas nan Teren an ki Kapab Absòbe Dlo	20%
Estanda pou Fòm Bilding	
Sifas atè a	4,000 pye kare maksimòm
Wotè	50 pye / 4 etaj maksimòm

*Lakou dèyè ki pi gwo (ki kite plas pou pyebwa ak espas ouvè)*

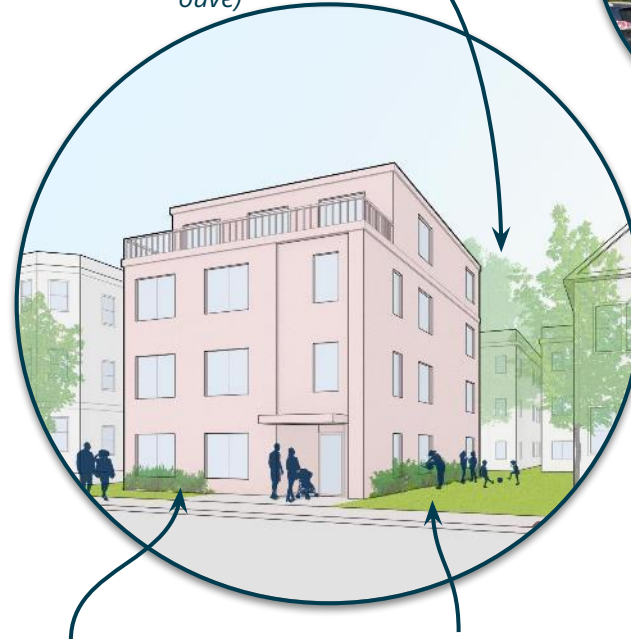

*Espas lakou devan ki pi gwo*

*Lakou sou kote ki pi gwo*





# Distri S-1: Aktivite nan Ri Prensipal

Bilding ki plis bilding rezidansyèl men ki kapab gen ti espas komèsyal nan pati devan an oswa biwo nan anba lakay la.

## Itilizasyon

- Nou otorize ti komès an detay ki tou pre sou katye a tankou ba, galri atistik, oswa magazen ki vann manje ki pa twò gwo nan anba lakay la, menm si gen moun ki souvan rete nan anba lakay la
- Nou egzijè pou moun abite nan etaj ki anlè yo

## Fòm

- Ti lakou sou kote ak ti lakou devan pou ofri plis zòn ki kapab absòbe dlo epi yon tanpon avèk zòn ki pi piti epi ki pi gwo yo



*Ti lakou devan*

# Distri S-1: Aktivite nan Ri Prensipal

Estanda ki gen rapò ak Teren	
Kouvèti Sifas Teren an	70%
Lakou Devan	6 pye minimòm
Lakou Dèyè	Ant 10 ak 15 pye minimòm
Lakou sou Kote	14 pye antou (3 pye minimòm)
Sifas nan Teren an ki Kapab Absòbe Dlo	15%
Estanda pou Fòm Bilding	
Sifas atè a	8,000 pye kare maksimòm
Lajè Bilding nan	120 pye maksimòm
Wotè	50 pye / 4 etaj maksimòm



*Lajè  
maksimòm  
bilding nan*

*Yo otorize ti magazen  
katye ak aktivite  
komèsyal nan anba  
lakay la*

*Fòk gen lakou sou kote  
ki pi gwo epi ki kapab  
ajiste*



## Distri S-2: Itilizasyon Ri Prensipal la pou Divès Aktivite

Bilding ki nan ri prensipal la ki gen boutik ak magazen nan anba lakay la se prensipal kondisyon an.

### Itilizasyon

- Kapab genyen ti biznis ak biznis mwayen nan katye a, men fòk yo nan anba lakay la
- Kapab genyen moun ki rete nan etaj anlè yo ak kèk ti magazen ki vann an detay

### Fòm

- Bilding ki pa twò wo ki kapab plen devan teren an (konstriksyon ki fèt yon fason ki pwòch) pou ede kreye yon peyizaj ki sanble ak "ri prensipal la".
- Mwens tè pou bilding yo nan ti distri yo pou asire toujou gen espas ouvè oswa lakou



# Distri S-2: Itilizasyon Ri Prensipal la pou Divès Aktivite

Estanda ki gen rapò ak Teren	
Kouvèti Sifas Teren an	70%
Lakou Devan	2 pye minimòm
Lakou Dèyè	Ant 10 ak 15 pye minimòm
Lakou sou Kote	Ant 5 ak 15 pye minimòm (0 pye si l kole ak mi separasyon)
Sifas nan Teren an ki Kapab Absòbe Dlo	15%
Estanda pou Fòm Bilding	
Sifas atè a	15,000 pye kare maksimòm
Lajè Bilding nan	150 pye maksimòm
Wotè	65 pye / 5 etaj maksimòm
Espas pou Amenajman Deyò	20%

*Espas pou Amenajman Deyò*



*Melanj biznis ak kote pou moun rete nan anba lakay*

*Zòn ki kapab absòbe dlo ak mwens sifas teren pou asire gen ase espas pou plante epi mete zòn tanpon*



## Distri S-3: Ri Prensipal ki Gen Anpil Aktivite

Bilding rezidansyèl ak ti otèl ki nan ri prensipal nan katye yo avèk yon dividal magazen ak sèvis nan anba lakay la.

### Itilizasyon

- Anba lakay yo kapab resevwa aktivite nan yon pi gwo nivo epi li atire moun nan lari ak sou plas tankou espektak an dirèk oswa yon gwo sal espò
- Fòk genyen aktivite nan anba lakay la
- Fòk gen moun ki abite nan etaj ki anlè yo

### Fòm

- Otorizasyon pou konstwi bilding ki pi wo pase wotè mwayèn nan, kote n ap aplike kondisyon ki gen nan konstriksyon ki fèt yon fason ki pwòch nan ri prensipal la
- Nou otorize moun itilize plis espas sou tè yo



# Distri S-3: Ri Prensipal ki Gen Anpil Aktivite

Estanda ki gen rapò ak Teren	
Kouvèti Sifas Teren an	90% (70% sou gwo moso tè yo)
Lakou Devan	2 pye minimòm
Lakou Dèyè	Ant 10 ak 15 pye minimòm
Lakou sou Kote	Ant 5 ak 15 pye minimòm (0 pye si l kole ak mi separasyon)
Estanda pou Fòm Bilding	
Sifas atè a	20,000 pye kare maksimòm
Lajè Bilding nan	150 pye maksimòm
Wotè	85 pye / 7 etaj maksimòm
Espas pou Amenajman Deyò	20%

Otorizasyon pou bati bilding ki pa twò wo



Fòk yo itilize anba lakay la pou fè biznis ak gwo aktivite komèsyal



Retresi espas ant bilding yo ak gwo tèren yo pou pèmèt ri prensipal la kontinye

# Distri S-4: Plas ki Gen Anpil Aktivite

Bilding ki pa twò wo ki gen divès magazen ak aktivite nan premye etaj la epi ki nan yon katye kote ou jwenn diferan kalite biznis.

## Itilizasyon

- Etaj anlè pou moun rete oswa pou moun divès kalite aktivite komès
- Moun kapab itilize anba lakay la yon pakèt fason
- Fòk genyen aktivite nan anba lakay la
- Yo kapab itilize sèlman etaj anlè yo pou moun rete

## Fòm

- Otorizasyon pou konstwi bilding ki pi wo pase wotè mwayèn nan, kote n ap aplike kondisyon ki gen nan konstriksyon ki fèt yon fason ki pwòch nan ri prensipal la
- Pi gwo distans ant do bilding yo ak distri rezidansyèl yo



# Distri S-4: Plas ki Gen Anpil Aktivite

Estanda ki gen rapò ak Teren	
Kouvèti Sifas Teren an	90% (70% sou gwo moso tè yo)
Lakou Devan	2 pye minimòm
Lakou Dèyè	Ant 3 pye ak 20 pye minimòm
Lakou sou Kote	5 pye minimòm (0 pye si l kole ak mi separasyon)
Estanda pou Fòm Bilding	
Sifas atè a	25,000 pye kare maksimòm
Lajè Bilding nan	200 pye maksimòm
Wotè	85 pye / 7 etaj maksimòm
Espas pou Amenajman Deyò	25%

*Fòk gen plis zòn ak espas ouvè*



*Yo kapab fè plis aktivite nan etaj anlè a*

*Yo kapab fè aktivite nan anba lakay la*





# Depase Règ Zonaj Ia

Toudabò, zonaj Plas ak Ri a defini gwoès maksimòm yon bilding. Apresa, bagay tankou Boston Design Vision, kontribisyon kominote a, ak BPDA Design Review pèmèt yo adapte pwojè a nan estil ak egzijans kontèks lokal la.

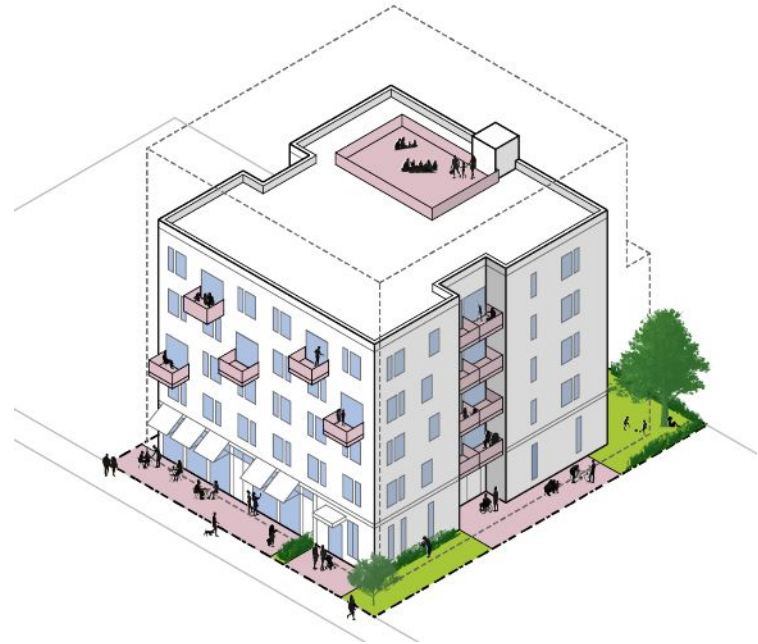
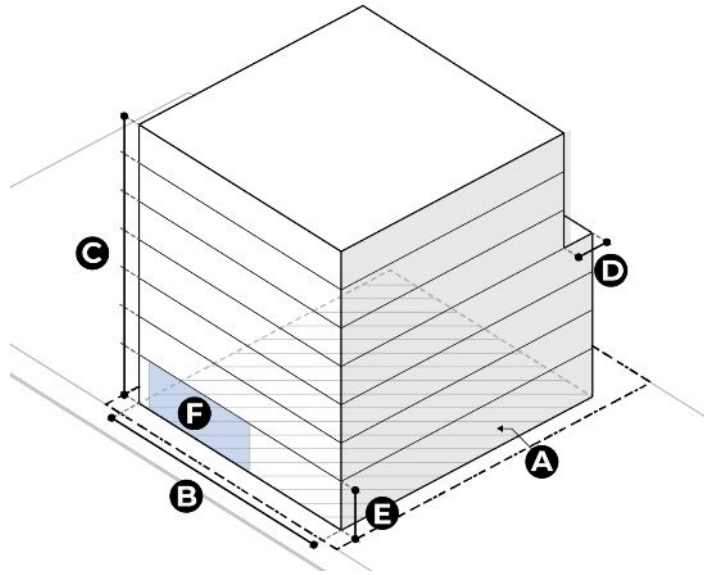

Limit Zonaj Ia

Pwojè Konstriksyon ki Fèt Ia

A woman wearing a light green jacket and a white headband stands with her back to the camera, leaning against a black bicycle with yellow handlebars. She is positioned in front of a purple-painted storefront. The central feature is a double wooden door with glass panels, which is slightly ajar. The glass panels are covered with various stickers, including one with the number '264' and another with '369'. To the left and right of the door are black wrought-iron gates. The storefront has large windows on either side, reflecting the street scene. In the foreground, two black metal bollards are visible on the sidewalk. The overall scene is brightly lit, suggesting daytime.

# Modèlizasyon nan itilizasyon tè a

# Règleman pou Itilizasyon Tè

Kòd Zonaj Boston an kontwole **fason nou kapab itilize tè yo**

Yo delege *chak* itilizasyon tè a kòm **otorize, sou kondisyon oswa entèdi** nan chak zòn nan vil la

- Sou **kondisyon** vle di nou gen obligasyon pou gen yon pèmi itilizasyon, ki baze sou yon ansanm kritè, Konsèy Kontestasyon Zonaj bay

# Difikilte

## Règleman Itilizasyon ki Gen Kounye a:

- li egziste **plizyè kote nan kòd la** (chak atik pou katye yo ansanm ak kòd debaz la)
- yo **difisil pou konprann**, alafwa pou piblik la ak pou Ekip Depatman Sèvis Enspeksyon k ap egzamine pèmi pou konstwi yo.
- epitou yo pa **ajou** epi yo pa toujou reponn ak objektif planifikasyon nou gen kounye a



# Opòtinite

Men Sa Nouvo Règ Itilizasyon yo Genyen ladan yo:

- **tablo ki pi fasil pou konprann** ki melanje itilizasyon ki menm yo epi ki retire ansyen itilizasyon yo
- **definisyon ki amelyore**
- **nòm pou itilizasyon ak pèfòmans** lè sa apwopriye
- Li tounen baz **refòm zonaj nan tout vil la** ak yon espas inik kote nou kapab fè modifikasyon alavni

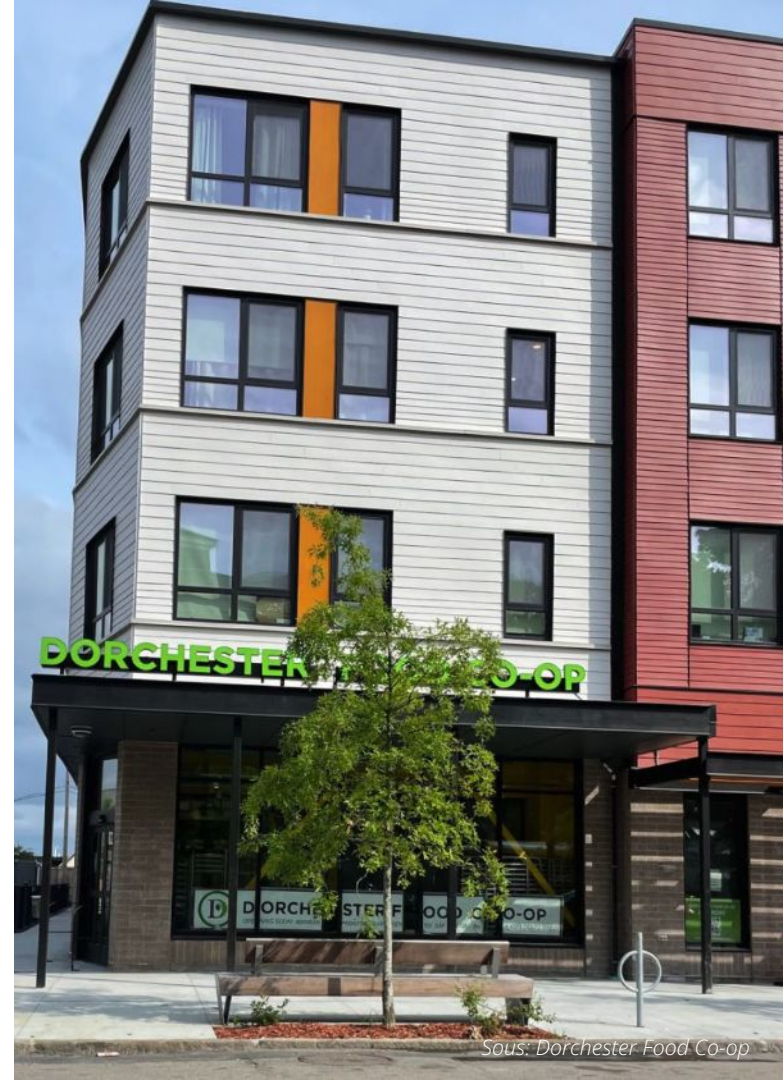

# Definisyon Premye Etaj ki "Gen Aktivite"

## Itilizasyon Premye Etaj pou Fè Aktivite

- Gadri/Sant ki Bay Granmoun Swen
- Sant Kominotè
- Makèt
- Espèktak/Evènman
- Espas kreyasyon
- Mize oswa Galri Atizay
- Restoran
- Etablisman ki Vann Kanabis an Detay
- Magazen ki Vann an Detay
- Lwazi Anndan
- Etablisman Sèvis
- Klèb Sosyal

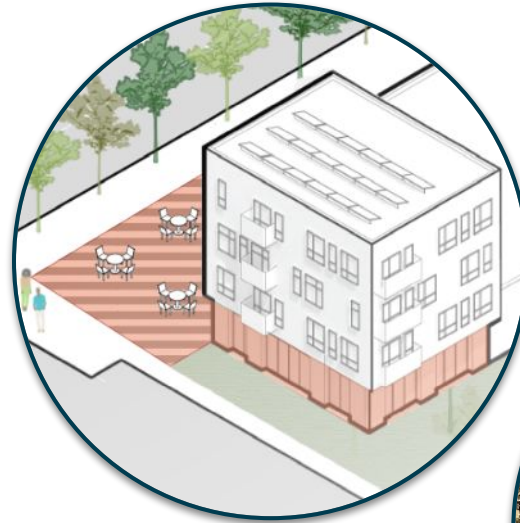

# Sant Kominotè

Kreyasyon nouvo Sant Kominotè ki gen ladan li sant kominotè tradisyonèl ak lòt espas kote pou moun rasanble, tankou bibliyotèk.

Sa yo konsidere tankou yon itilizasyon aktif.

	S0	S1	S2	S3	S4
Sant Kominotè	C	A	A	A	A



*Boston Public Library, Mattapan*



*Roslindale Community Center*



*Family Nurturing Center, Dorchester*



*BCYF Curley Center, South Boston*

# Espektak/Èvènman

**Limit kapasite yo** se limit yo fikse pou detèmine kantite moun ki kapab patisipe nan Espektak/Èvènman ki nan zòn diferan epi ki pa menm gwo.

Piti - Jiska 500 moun

Mwayen - 500 jiska 2000 moun

Gwo - 2,000 jiska 10,000 moun

Gwo anpil - 10,000 oswa plis moun

	S0	S1	S2	S3	S4
Espektak/Èvènman - Piti	F	A-G	A-G	A-G	A
Espektak/Èvènman - Mwayen	F	F	C-G	A-G	A
Espektak/Èvènman - Gwo	F	F	F	C	C
Espektak/Èvènman - Gwo Anpil	F	F	F	F	F

## Piti



Sous: Jonah Ollman

Brighton Music Hall - 476 moun

## Mwayen



Strand Theatre - 1,400 moun

## Gwo



Sous: Structures

Symphony Hall - 2,371 moun

## Gwo Anpil



Sous: TD Garden

TD Garden - 19,580 moun



# Restoran

Zonaj ki genyen kounye a separe Restoran, Restoran kote ou achte manje pou ale lakay, Restoran kote yo lonje manje a nan machin ou, Restoran kote yo fè espektak, Ba, ak Ba kote yo fè espektak.

Nouvo zonaj la gen ladan l yon kategori ki rele "Restoran" (ki separe selon gwosè), ansanm ak "restoran kote yo lonje manje a nan machin ou" ak "espektak/evènman" ki gen rapò ak kategori yo. Moun kapab achte manje pou yo ale lakay yo nan tout restoran yo.

Piti - mwens pase 2,500 pye kare  
Gwo - omwen 2,500 pye kare

"espektak/evènman sipleman tè" pou restoran/ba ki ka divèti kliyan yo pandan yo ap manje ak bwè (pa egzanp, The Bebop)



	S0	S1	S2	S3	S4
Restoran - Piti	C-G	A-G	A-G	A	A
Restoran - Gwo	F	C-G	A-G	A	A
Restoran ki Kote yo Lonje Manje nan Machin	F	F	F	F	F
Espektak/Evènman	C	A	A	A	A

## Piti



Cafe JuiceUp, Mattapan - 700 pye kare

## Gwo



Bell in Hand Tavern - 6,000 pye kare

# Magazen ki Vann an Detay

Zonaj ki genyen kounye a separe "ti detayan lokal", "gwo detayan", "magazen ki vann alkòl" ak "plàn".

Nouvo zonaj la mete tout sa yo nan yon "Magazen ki Vann an Detay", men li separe yo selon gwosè.

- Piti - mwens pase 2,500 pye kare
- Mwayen - ant 2,501 ak 10,000 pye kare
- Gwo - ant 10,001 ak 50,000 pye kare
- Gwo Anpil - omwen 50,000 pye kare

	S0	S1	S2	S3	S4
Magazen ki Vann an Detay - Piti	F	A-G	A-G	A-G	A
Magazen ki Vann an Detay - Mwayen	F	C-G	A-G	A-G	A
Magazen ki Vann an Detay - Gwo	F	F	C-G	A-G	A
Magazen ki Vann an Detay - Gwo Anpil	F	F	F	F	C

## Piti



Birch Florist, Roslindale - 750 pye kare

## Mwayen



Sous: Eliana Sanchez

Walgreens, East BOSTON - 9 000 pye kare

## Gwo



Sous: Kat Google

T.J. Maxx, Back Bay - 45,000 pye kare

## Gwo Anpil



Sous: Suffolk Construction

Target, Fenway - 150,000 pye kare



**Soti nan Plan pou Katye  
rive nan Nouvo Zonaj  
Plas ak Ri**

# PLAN: Mattapan anvizaje yon avni kote...

Pou kounye a,  
rezidan Mattapan  
yo estab nan kay yo  
epi nouvo rezidan  
yo gen opsyon  
lojman abòdab.



**Zonaj la kapab...** fè  
genyen plis  
ogmantasyon lojman  
nan gwo plas ak ri yo  
epi ozalantou yo.



# PLAN: Mattapan anvizaje yon avni kote...

Moun ki abite  
Mattapan yo gen  
mwayen transpò  
piblik ki an sekirite  
epi ki fyab pou yo  
ale travay, lekòl, ak  
nan espas kominotè  
nan Mattapan ak  
nan tout Boston



## Zonaj la kapab...

rann li fasil pou gen  
plis travay ak  
konstriksyon lojman  
nan zòn kote ki gen  
transpò piblik yo.



# PLAN: Mattapan anvizaje yon avni kote...

Mattapan Square ak  
lòt sektè nan katye yo  
gen **biznis lokal** ki  
**dinamik**, k ap  
**pwospere** ak **espas**  
**kiltirèl** ki reflete  
bezwen rezidan yo epi  
ranfòse idantite katye  
a



## Zonaj la kapab...

pèmèt yo konstui plis  
ti biznis ak sant  
kiltirèl epi li kapab  
egzije pou gen  
aktivite ki fèt nan  
anba lakay la.



# Rekòmandasyon PLAN: Mattapan

Yo te fè rekòmandasyon  
zonaj yo pou tout zòn etid  
la epi yo baze sou menm  
Soudistri Zonaj ki egziste  
nan Mattapan jounen jodi  
a.



# Pwen sou Plas ak Ri

Zonaj Plas ak Ri a konsantre sou zòn yo idantifye tankou "Pwen Santral" ak "Aks" nan PLAN: Mattapan.

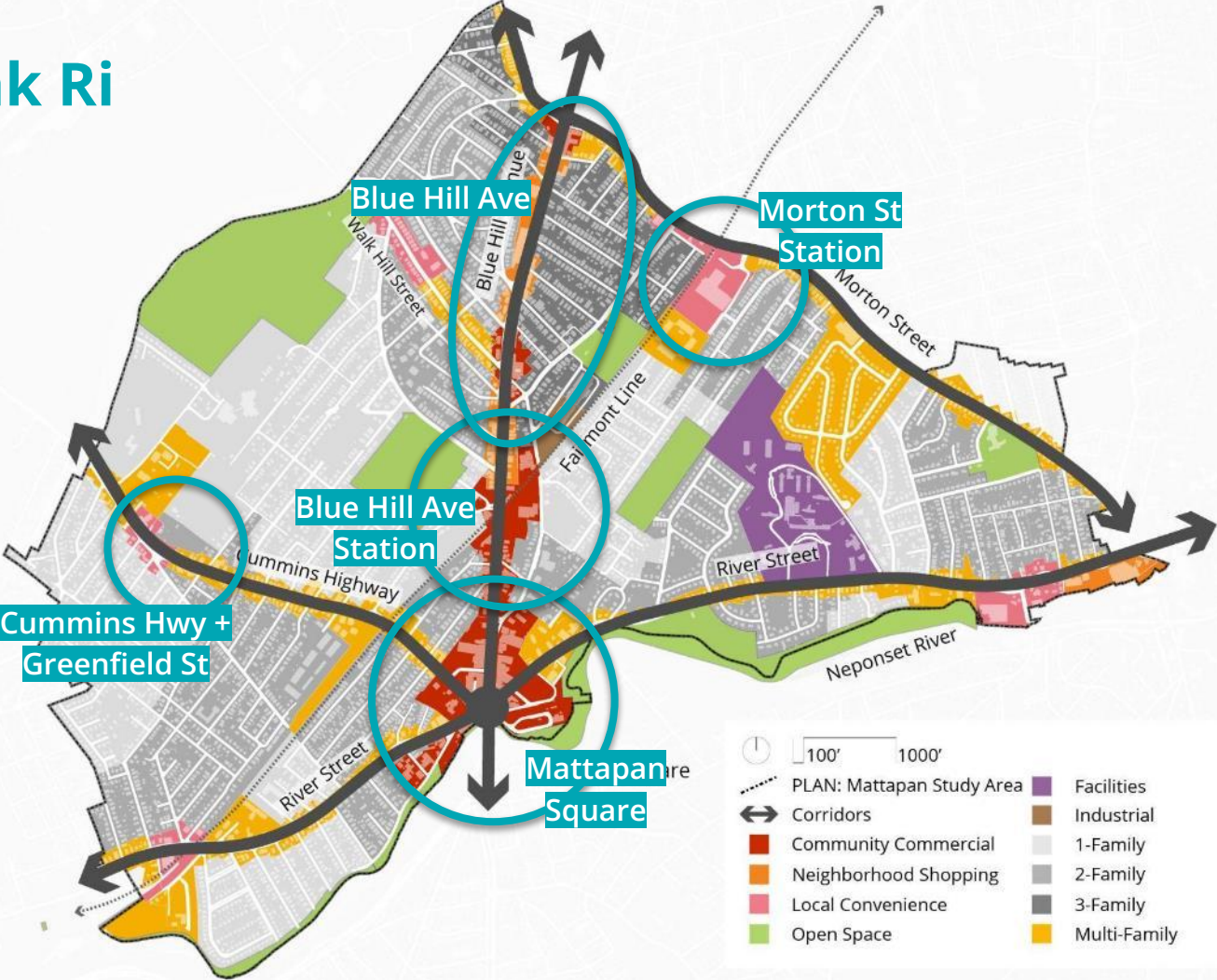



# Nouvo Pwojè Zonaj Plas ak Ri

Yo pa bezwen katografye yon Plas oswa Ri antye avèk menm Distri Plas ak Ri a; yo kapab **adapte yo pou yo pi byen entegre nan anviwònman an ak plan yo prevwa a.**

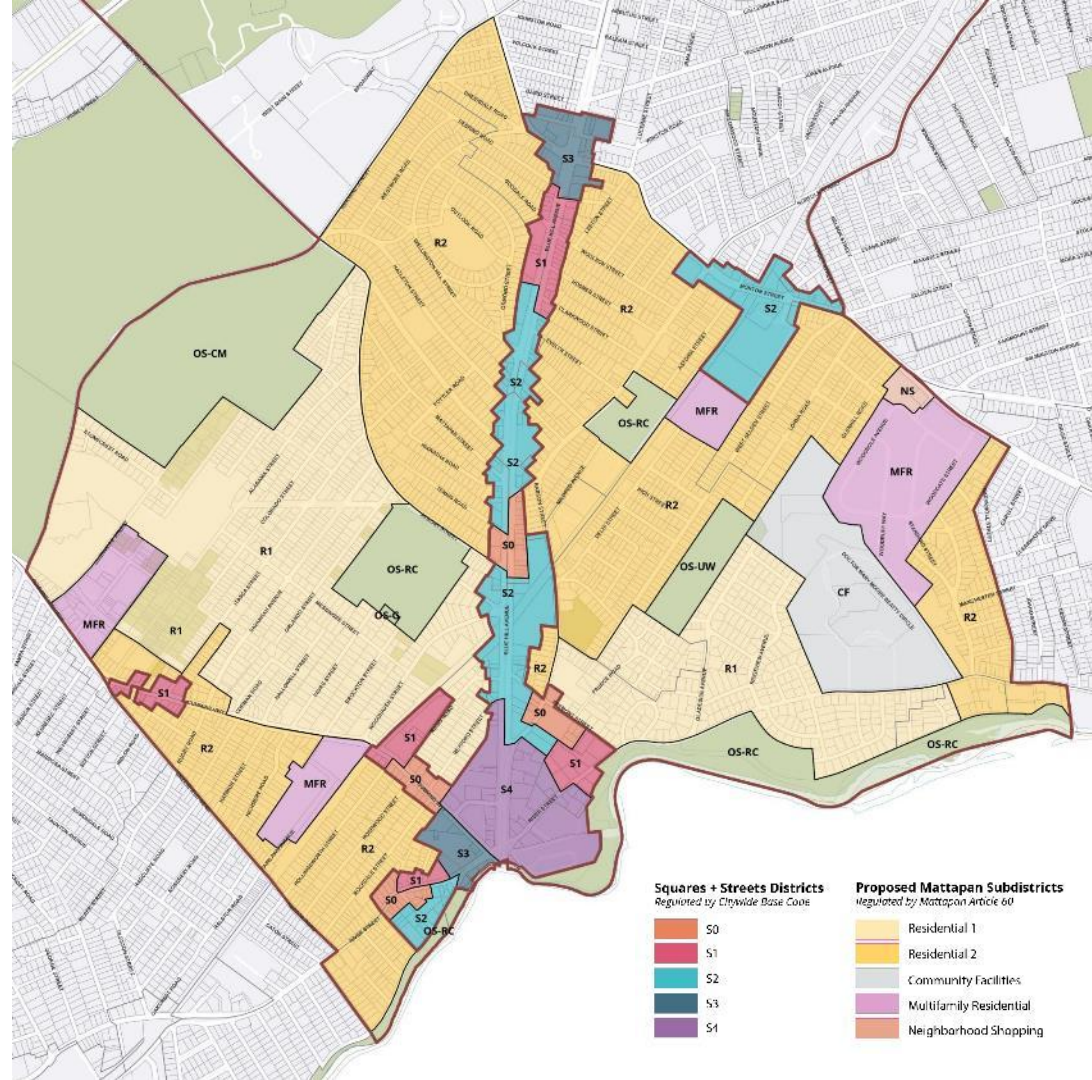

# Konparezon avèk Zonaj ki La Deja a

Distri Plas ak Ri yo ranplase Soudistri Magazen nan Katye ak Soudistri Komèsyal nan Kominote a, epi li gen ladan l kèk zòn ki genyen zonaj rezidansyèl kounye a.

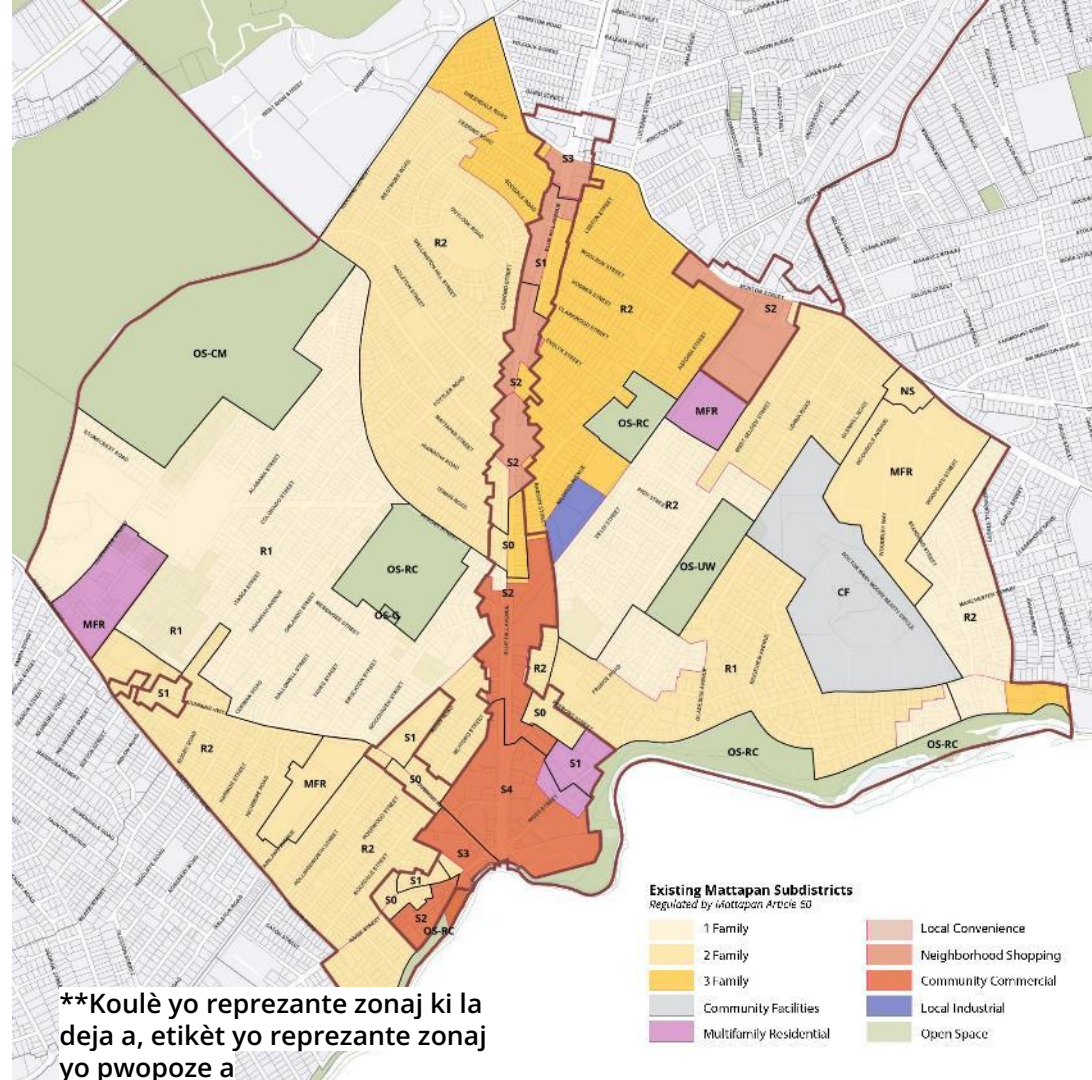

\*\*Koulè yo reprezante zonaj ki la deja a, etikèt yo reprezante zonaj yo pwopoze a

# Fason pou li zonaj yo pwopoze a epi bay opinyon



# Fason pou Li Zonaj yo Pwopoze a (Nan tout vil la)

WJOJÈ Amandman Tèks Zonaj Plas ak Ri

Rezime Amandman ak Gid Referans

Gid Vizyèl pou Modènizasyon Itilizasyon Tè

**Compiled Draft Text Amendment for Squares + Streets**

Last revised: December 5, 2023

Contents	Page
<b>Overview</b>	
1. <a href="#">Amendment Overview and Reference Guide</a>	2
<b>Primary Additions</b>	
2. <a href="#">Article 26 (Squares and Streets)</a>	9
3. <a href="#">Summary of Changes to other Articles</a>	14
4. <a href="#">Article 8 (New Use Table)</a>	20
5. <a href="#">Article 23 (Parking)</a>	73
<b>Smaller Changes</b>	
6. <a href="#">Article 3 (Establishment of Zoning Districts)</a>	80
7. <a href="#">Article 6 (Conditional Uses)</a>	90
8. <a href="#">Article 11 (Signs)</a>	94
9. <a href="#">Article 13 (Dimensional Requirements)</a>	102
10. <a href="#">Article 18 (Front Yards)</a>	105
11. <a href="#">Article 19 (Side Yards)</a>	108
12. <a href="#">Article 22 (Yard Regulations)</a>	112
13. <a href="#">Article 24 (Off-Street Loading)</a>	115

**Squares + Streets Amendment Summary**

Squares + Streets is a planning and zoning initiative to modernize regulations for how development can happen in Boston's commercial centers. This draft text amendment will adjust the zoning code to enable these changes. By itself, none of these changes have any immediate effect on any existing zoning districts anywhere in the city. Zoning districts must be mapped, through a zoning map amendment, to take effect. The BPDA plans to conduct a full process for zoning map amendments in Squares + Streets as part of Small Area Plans, beginning in early 2024.

The new Squares + Streets districts involve three additions to the zoning code—Article 26 (Squares + Streets District Regulations), Article 8 (Use Table), and Article 23 (Parking)—that enable the bulk of the streamlining. Other minor changes make these consistent with the rest of the zoning code.

**New Zoning:** Article 26 (Squares + Streets), Article 8 (Use Table), and Article 23 (Parking)

**Article 26: A new article for the Boston Zoning Code, creating the Squares + Streets districts.** Sections 26-1 and 26-2 describe the purpose of the five Squares + Streets districts, and give a summary of each of them (S-0 through S-4). Following that, the article includes a diagram explaining the district dimensional standards and a table with more detailed dimensional regulations, described in more detail in the following reference guide. It also provides "additional use and performance standards," which provide some additional information that cannot fit inside the other edits to Article 8.

**Article 8: A modernized use table for Squares + Streets and other future citywide zoning districts.** The new use table will be named Table A and the existing base code use table will be renamed Table B. The Squares + Streets districts will, at the moment, be the only districts operating under the new Table A. Table A is a comprehensive modernization of Boston's definitions of what is allowed or not allowed in the city's different zoning districts and subdistricts.

In addition to the Draft Article 8 text, a **companion Land Uses Visual Guide is available** on the Squares + Streets Zoning Districts webpage that provides photo examples of each land use.

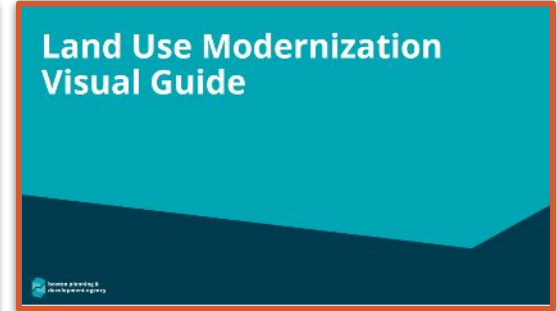

**Entertainment/Events**

A facility which regularly hosts live entertainment events, including but not limited to event centers, theaters, cinemas, night clubs, concert halls, arenas, and stadiums, or similar use. Such use may receive a Live Entertainment License.

<p><b>Small</b> - An entertainment facility with a capacity of up to 500 persons.</p>  <p>Brighton Music Hall - 476 people</p>	<p><b>Medium</b> - An entertainment facility with a capacity of 501-2,000 persons.</p>  <p>Shawmut Theatre - 1,422 people</p>
<p><b>Large</b> - An entertainment facility with a capacity of 2,001-10,000 persons.</p>  <p>Symphony Hall - 3,371 people</p>	<p><b>Extra Large</b> - An entertainment facility with a capacity of greater than 10,000 persons.</p>  <p>TD Garden - 19,580 people</p>

\*\*Li enpòtan anpil pou konprann amandman tèks la nan tout Vil la pou l aplike nan Mattapan



# Fè nou konnen sa w panse!

Vini nan Lè Biwo  
Vityèl Nou an Louvri!

**Espesifik pou  
Mattapan: 4 seyans  
an desanm  
(apremidi ak aswè)**

11, 13, 18, 20 desanm

**Nan tout vil la: 6  
seyans an desanm  
(apremidi ak aswè):**

7, 11, 12, 19, 20, ak 27  
desanm

Patisipe nan  
Pwochen Reyinyon  
Piblik la!

**Espesifik pou Mattapan:**

Reyinyon sou Pwojè Modifikasyon  
Zonaj (Kòmansman mwa janvye  
pou konfime)

Dènye Reyinyon sou Modifikasyon  
Zonaj (Kòmansman mwa fevriye  
pou konfime)

**Nan tout vil la:**

Reyinyon pou Pase Men nan  
Amandman Tèks Zonaj (8 janvye)

Dènye Reyinyon sou Amandman  
Tèks Zonaj (6 fevriye)

Angajman Anplis an  
Janvye

N ap fè jefò pou nou  
planifye lòt reyinyon  
fas-a-fas an **janvye  
2024** anvan peryòd  
pou fè kòmantè a  
fini.

Di nou Sa w Panse!

Di sa ou panse sou  
pwojè amandman  
zonaj yo kounye a  
nan fòm ki gen  
**peryòd kòmantè  
piblik la soti  
kounye a RIVE  
JISKA 28 JANVYE  
2024.**

# Opinyon (jiska prezan) epi Fason pou Abòde

*Kòmantè:*

Eksplike **fason zafè jwenn lisans ak aplikasyon kòd la fonksyone**

**Konparezon zonaj ki genyen kounye a** ak zonaj yo pwopoze a

Enkyetid sou **disponibilite pakin** nan Mattapan Square

Plis bilding oswa aktivite sou tè yo ka fè gen plis **blokis**

*Repons:*

**Òganize yon reyinyon piblik** an janvye avèk **kòlèg yo nan Konsèy Lisans lan**

**Kreye yon ansanm kat ki gen kòmantè** ki montre konparezon

Mete anplis yon **sistèm "Pakin Pataje"** pou biznis yo kapab pote kole pou yo itilize plas pakin yo

Fikse **limit pou gwosè** pou pèmèt yo bati kay ki pi piti

Zonaj pou itilizasyon miks kreye **plis zòn pou pyeton**

# Kijan Kòmantè Ou Kapab Fè Enpak sou Inisyativ

## Sa a?

*Kòmantè:*

"Mwen pa ka konprann kote \_\_\_\_\_ itilizasyon tè a ap entegre nan tablo a"

"Mwen kwè yo ta dwe entegre zòn sa a nan \_\_\_\_\_ Distri Zonaj la"

"Mwen pa konprann tèm ki nan \_\_\_\_\_ pati nan kòd zonaj la"

*Nenpòt lòt kòmantè, kesyon, ak enkyetid*

*Repons:*

Amelyore definisyon yo ak/oswa kreye nouvo itilizasyon pou li

Posibilite pou redefini limit distri yo pou yo pi byen reflekte objektif planifikasyon yo ak kondisyon ki la deja yo

Revize ak klarifye tèks ki nan kòd zonaj la pou moun ka konprann li byen

Yo jere yo youn apre lòt epi fè suivi lè sa nesesè



# Pwosesis Zonaj Plas ak Ri

## Plas ak Ri Mattapan (Aplikasyon Amandman Tèks la nan Tout Vil la)

Peryòd pou fè Kòmantè sou Pwojè a

Nou aksepte kòmantè jiskaske reyinyon Konsèy la rive

Nou aksepte kòmantè ak odyans piblik nan Komisyon Zonaj la

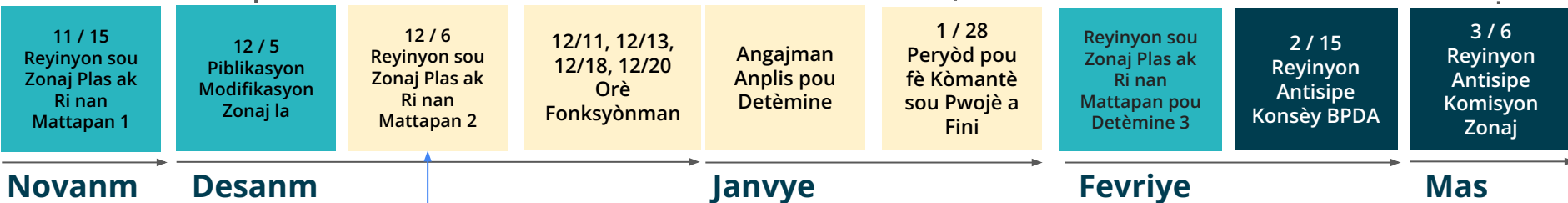

**NOU LA A**

## Plas ak Ri nan Tout Vil la (Amandman Tèks)

Peryòd pou fè Kòmantè sou Pwojè a

Nou aksepte kòmantè jiskaske reyinyon Konsèy la rive

Nou aksepte kòmantè ak odyans piblik nan Komisyon Zonaj la

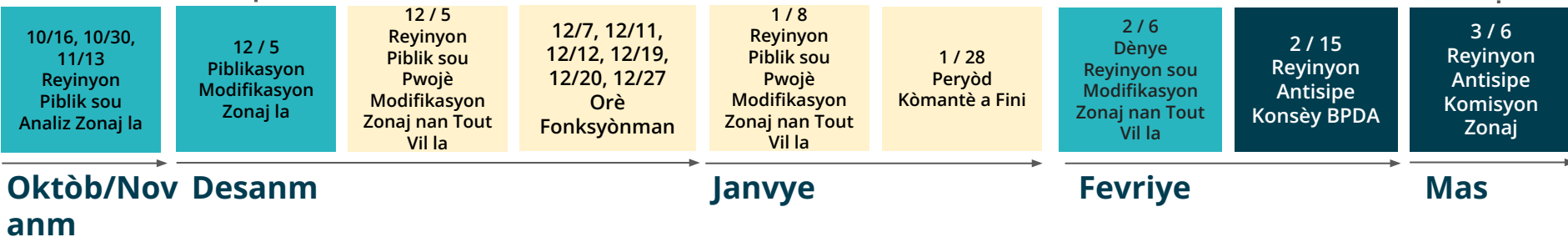

# Mèsi!

---

*pou w jwenn plis enfòmasyon sou jefò rezonaj sa yo, ale sou:*

*<https://www.bostonplans.org/planning/planning-initiatives/plan-mattapan>*